

RATR20 INA

Ball bearing units

TYPE: Housing units, Three-bolt flanged housing units, Sheet steel housing, Radial insert ball bearing with eccentric locking collar, Type RATR (INA)

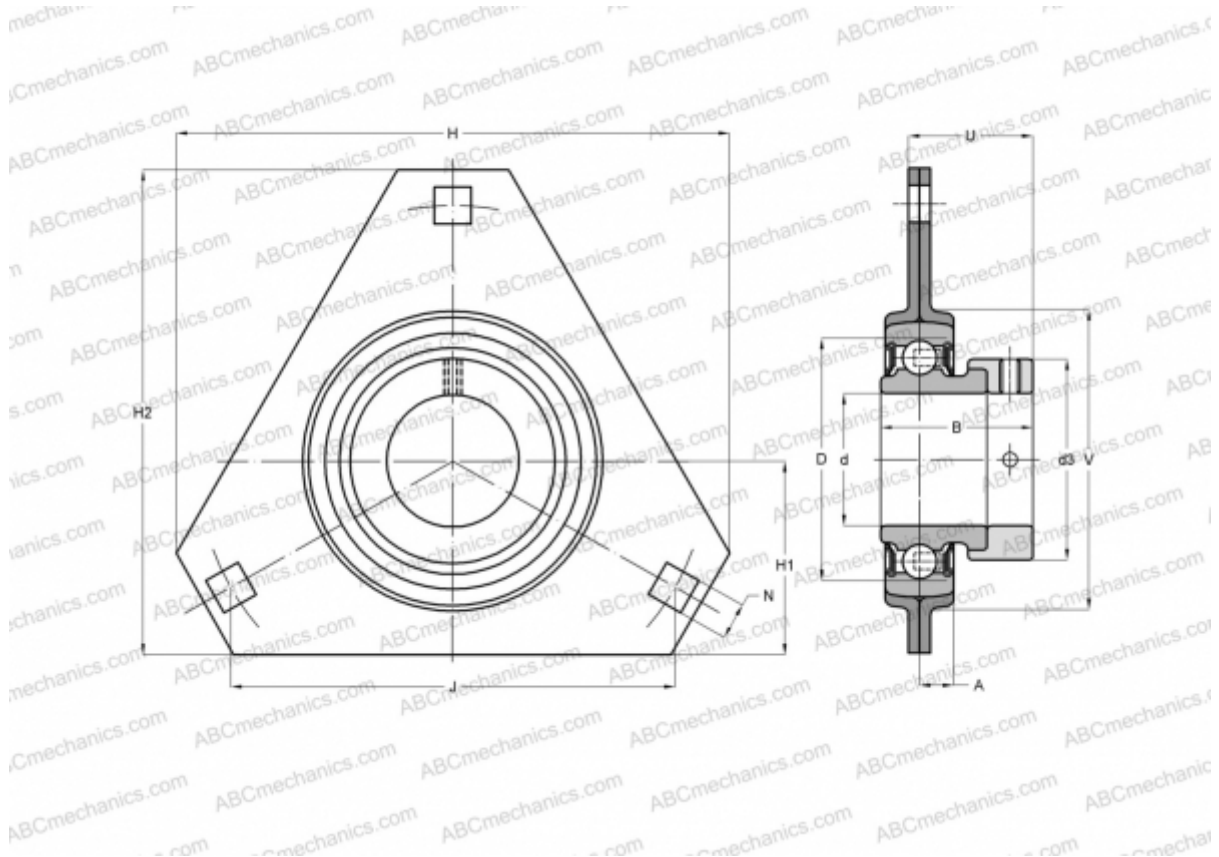

Technical specification

DIMENSIONS, MM

d	20,000
D	47,000
B	31,000
H	90,500
A	8,000
H2	76,200
J	71,500
H1	33,300
N	8,700
d3	33,000
U	25,500
V	55,000

WEIGHT, KG 0,280

Bearing	RAE20-NPP-B
Housing	FLAN47-MSTR

MANUFACTURER

x 2
[INA](#)

CALCULATION DATA

Basic dynamic load rating, C	12,800 kN
Basic static load rating, Co	6,600 kN