

RATR25 INA

Ball bearing units

TYPE: Housing units, Three-bolt flanged housing units, Sheet steel housing, Radial insert ball bearing with eccentric locking collar, Type RATR (INA)

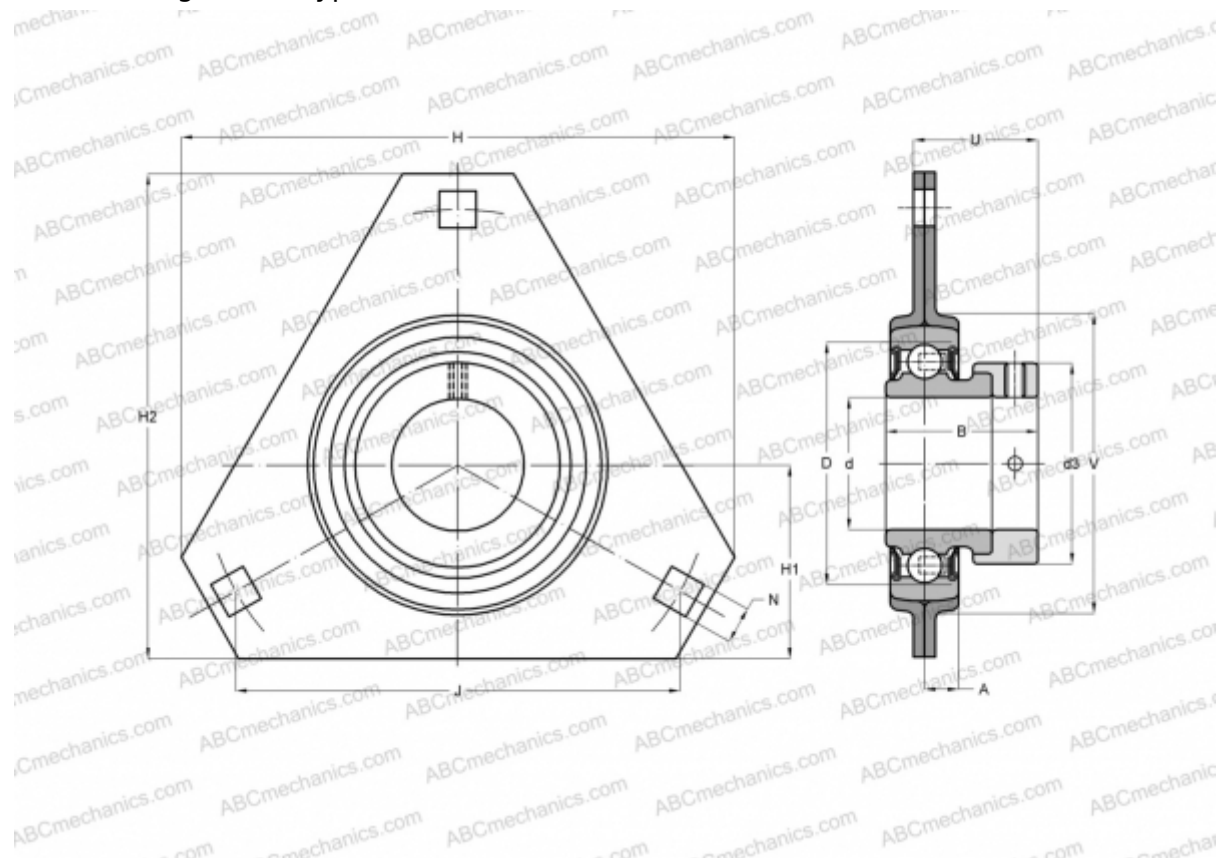

Technical specification

DIMENSIONS, MM

d	25,000
D	52,000
B	31,000
H	95,300
A	8,700
H2	80,500
J	76,000
H1	34,900
N	8,700
d3	37,500
U	25,500
V	60,000

WEIGHT, KG 0,320

Bearing	RAE25-NPP-B
Housing	FLAN52-MSTR

MANUFACTURER

x 2
[INA](#)

CALCULATION DATA

Basic dynamic load rating, C	14,000 kN
Basic static load rating, Co	7,800 kN