

RA25 INA

Ball bearing units

TYPE: Housing units, Three/four-bolt flanged housing units, Sheet steel housing, Radial insert ball bearing with eccentric locking collar, Type RA (INA)

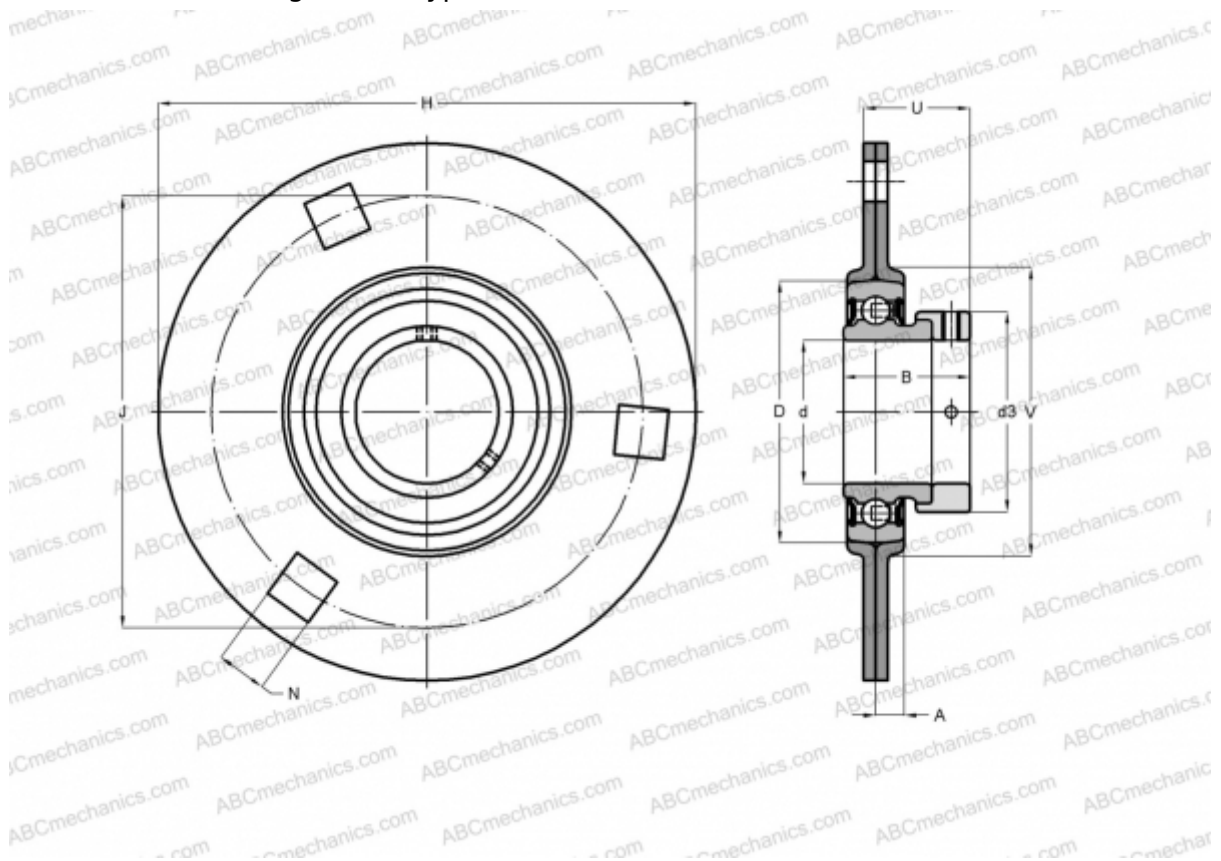

Technical specification

DIMENSIONS, MM

d	25,000
D	52,000
B	31,000
H	95,000
A	8,700
J	76,000
N	8,700
d3	37,500
U	25,500
V	60,000

WEIGHT, KG

0,370

Bearing	RAE25-NPP-B
Housing	FLAN52-MSB x

MANUFACTURER

[INA](#)

CALCULATION DATA

Basic dynamic load rating, C	14,000 kN
Basic static load rating, Co	7,800 kN