

## RA60 INA

Ball bearing units

TYPE: Housing units, Three/four-bolt flanged housing units, Sheet steel housing, Radial insert ball bearing with eccentric locking collar, Type RA (INA)

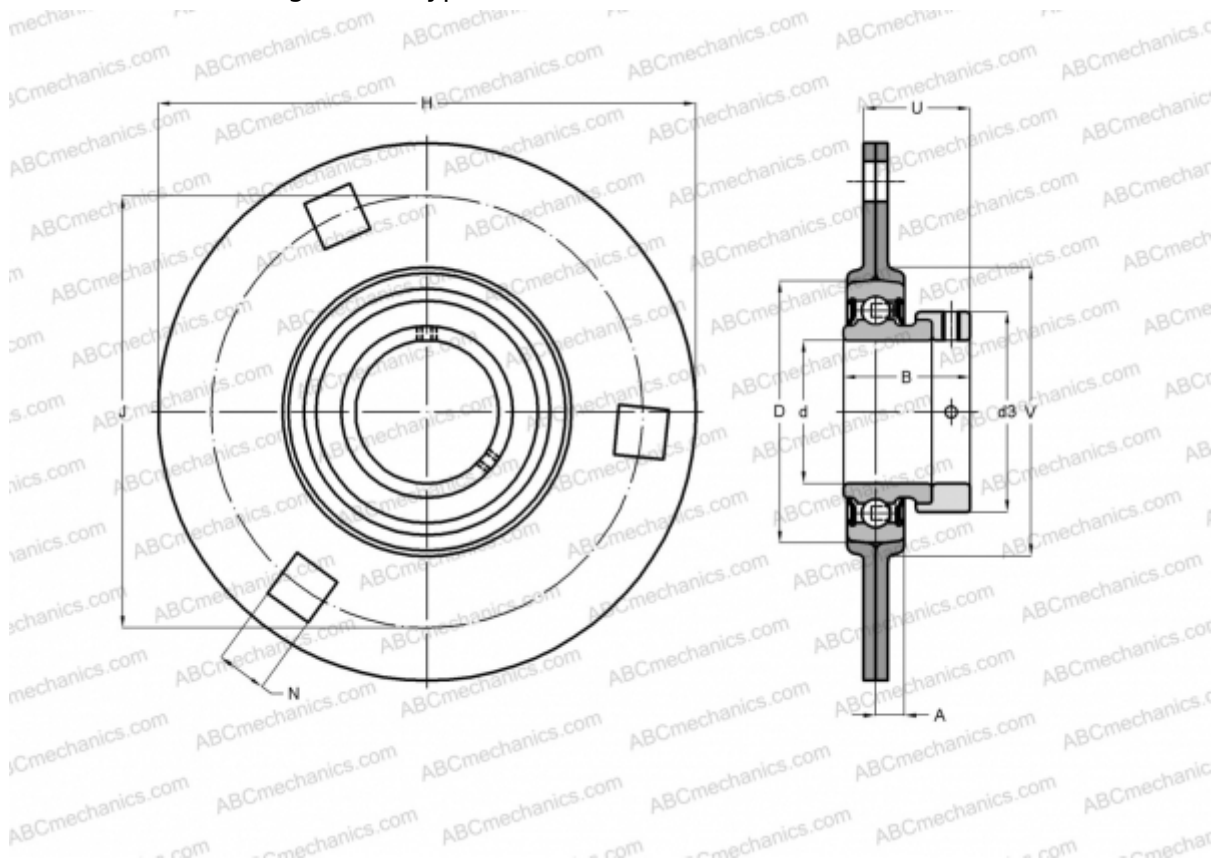

### Technical specification

#### DIMENSIONS, MM

d	60,000
D	110,000
B	53,100
H	176,000
A	12,000
J	148,000
N	13,500
d3	84,000
U	43,600
V	120,000

#### WEIGHT, KG

2,540

Bearing	GRAE60-NPP-B
Housing	FLAN110-MSB

x 2

#### MANUFACTURER

[INA](#)

#### CALCULATION DATA

Basic dynamic load rating, C	52,000 kN
Basic static load rating, Co	36,000 kN