

GRA30 INA

Ball bearing units

TYPE: Housing units, Three/four-bolt flanged housing units, Sheet steel housing, Radial insert ball bearing with eccentric locking collar, Type GRA (INA)

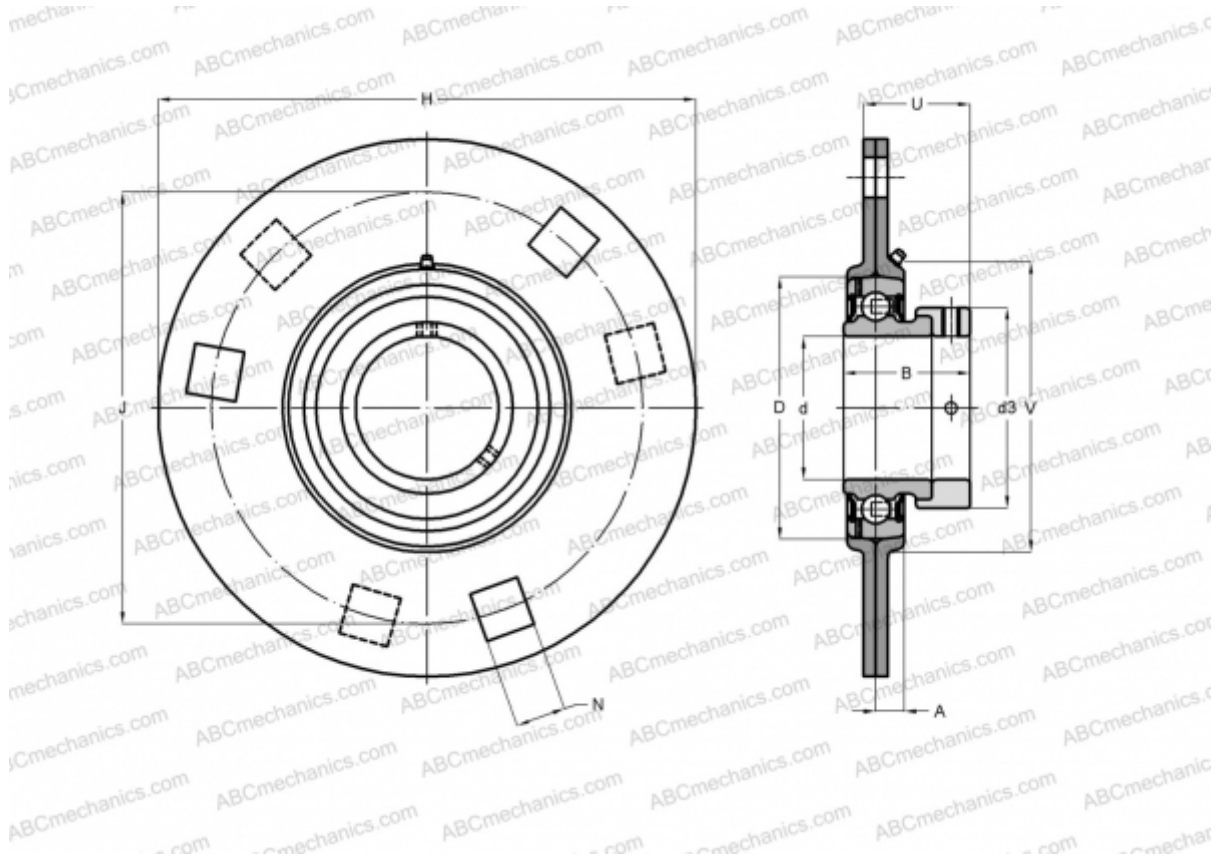

Technical specification

DIMENSIONS, MM

d	30,000
D	62,000
B	35,800
H	112,700
A	8,700
J	90,500
N	10,500
d3	44,000
U	29,200
V	71,000

WEIGHT, KG

0,610

Bearing	GRAE30-NPP-B
Housing	FLAN62- MSB/FLAN62- MSA x 1

MANUFACTURER

[INA](#)

CALCULATION DATA

Basic dynamic load rating, C	19,500 kN
Basic static load rating, Co	11,300 kN