

GRA35 INA

Ball bearing units

TYPE: Housing units, Three/four-bolt flanged housing units, Sheet steel housing, Radial insert ball bearing with eccentric locking collar, Type GRA (INA)

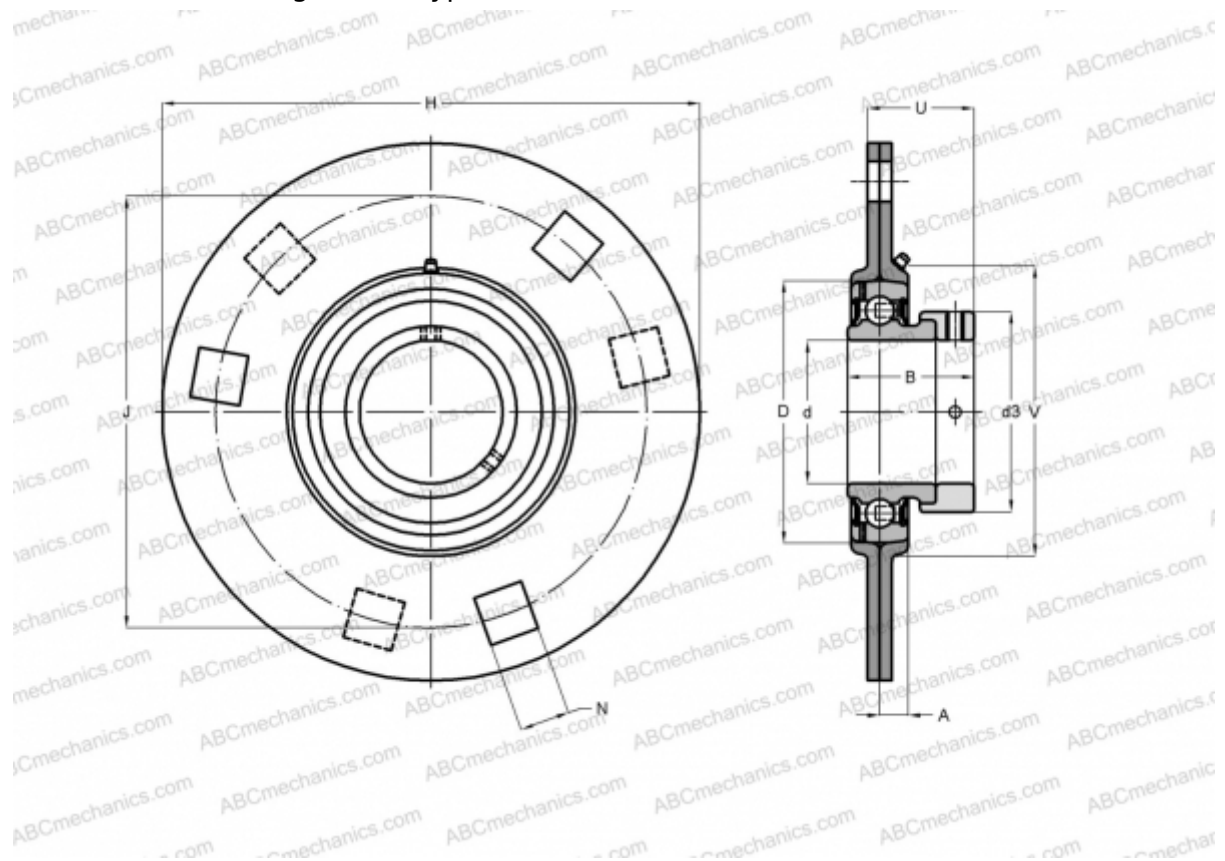

Technical specification

DIMENSIONS, MM

d	35,000
D	72,000
B	39,000
H	122,000
A	9,500
J	100,000
N	10,500
d3	51,000
U	32,000
V	81,000

WEIGHT, KG

0,820

Bearing	GRAE35-NPP-B
Housing	FLAN72- MSB/FLAN72- MSA x 1

MANUFACTURER

[INA](#)

CALCULATION DATA

Basic dynamic load rating, C	25,500 kN
Basic static load rating, Co	15,300 kN