

RAY12 INA

Ball bearing units

TYPE: Housing units, Three/four-bolt flanged housing units, Sheet steel housing, Radial insert ball bearing with grub screws in inner ring, Type RAY (INA)

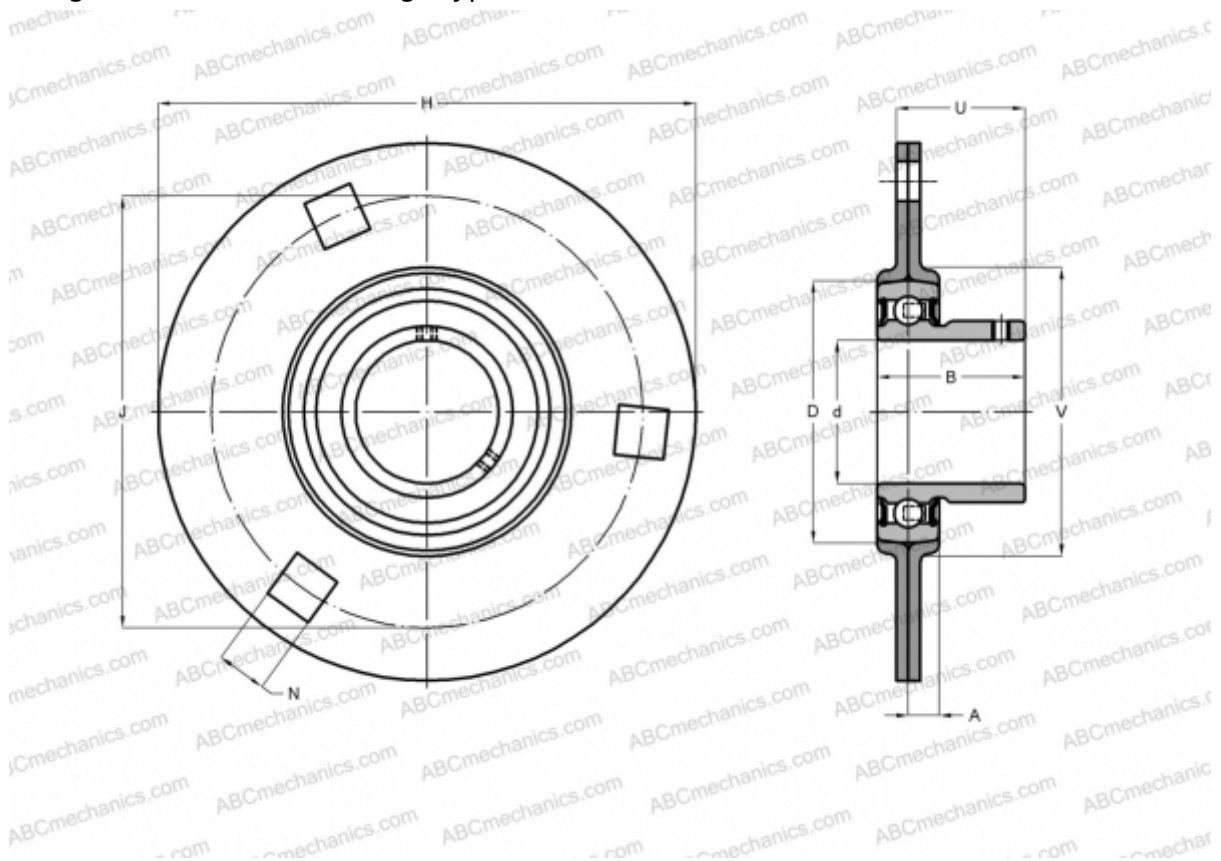

Technical specification

DIMENSIONS, MM

d	12,000
D	40,000
B	22,000
H	81,000
A	7,000
J	63,500
N	7,100
U	18,000
V	48,000

WEIGHT, KG 0,170

Bearing	AY12-NPP-B
Housing	FLAN40-MSB x

2

MANUFACTURER

[INA](#)

CALCULATION DATA

Basic dynamic load rating, C	9,800 kN
Basic static load rating, Co	4,750 kN