

RRY25-VA INA

Ball bearing units

TYPE: Housing units, Three/four-bolt flanged housing units, Sheet steel housing, Radial insert ball bearing with grub screws in inner ring, Anti-corrosion protection, without relubrication facility, type RRY..-VA (INA)

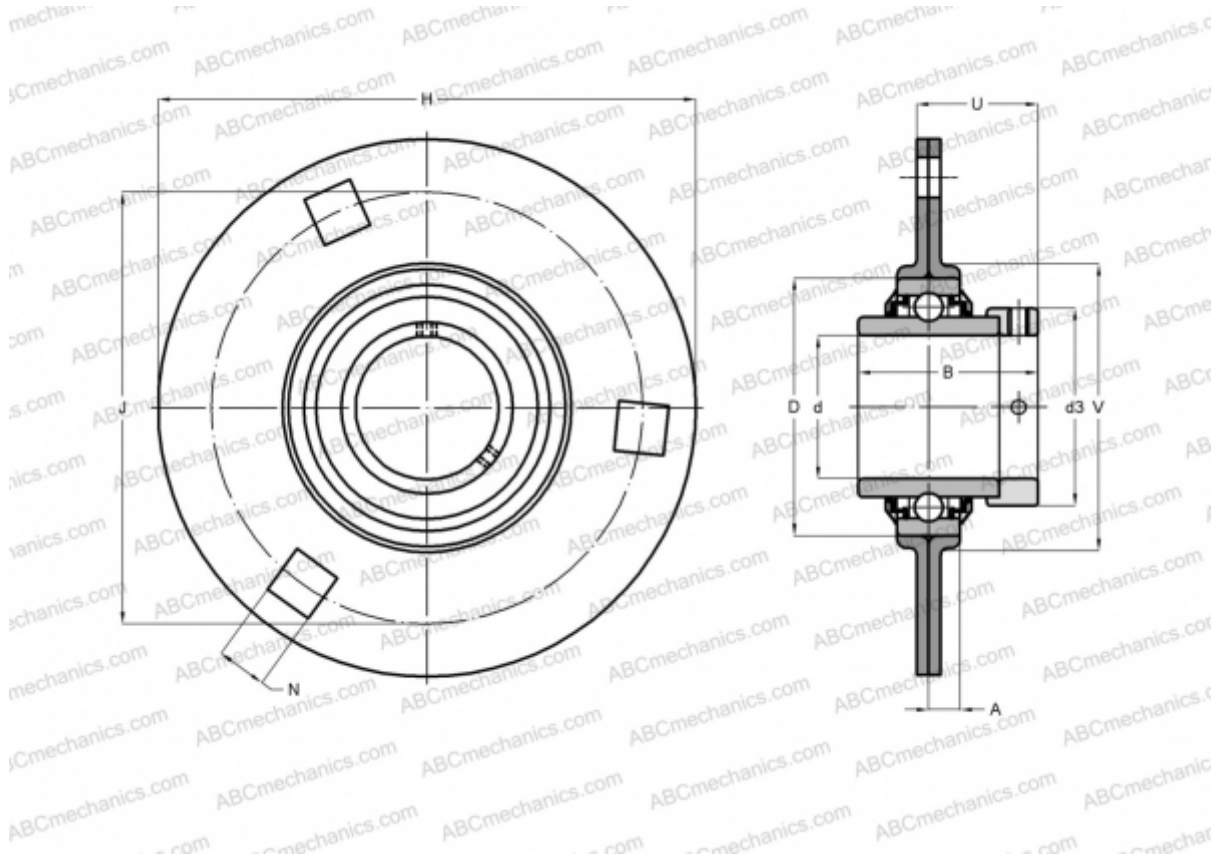

Technical specification

DIMENSIONS, MM

d	25,000
D	52,000
B	34,000
H	95,000
A	8,700
J	76,000
N	8,700
U	21,700
V	60,000

WEIGHT, KG 0,380

Bearing GYE25-KRR-B-
Housing FLAN52-MSB-
VA x 2

MANUFACTURER

[INA](#)

CALCULATION DATA

Basic dynamic load rating, C	14,000 kN
Basic static load rating, Co	7,800 kN