

## GRRY25-VA INA

Ball bearing units

TYPE: Housing units, Three/four-bolt flanged housing units, Sheet steel housing, Radial insert ball bearing with grub screws in inner ring, Anti-corrosion protection, type GRRY...-VA (INA)

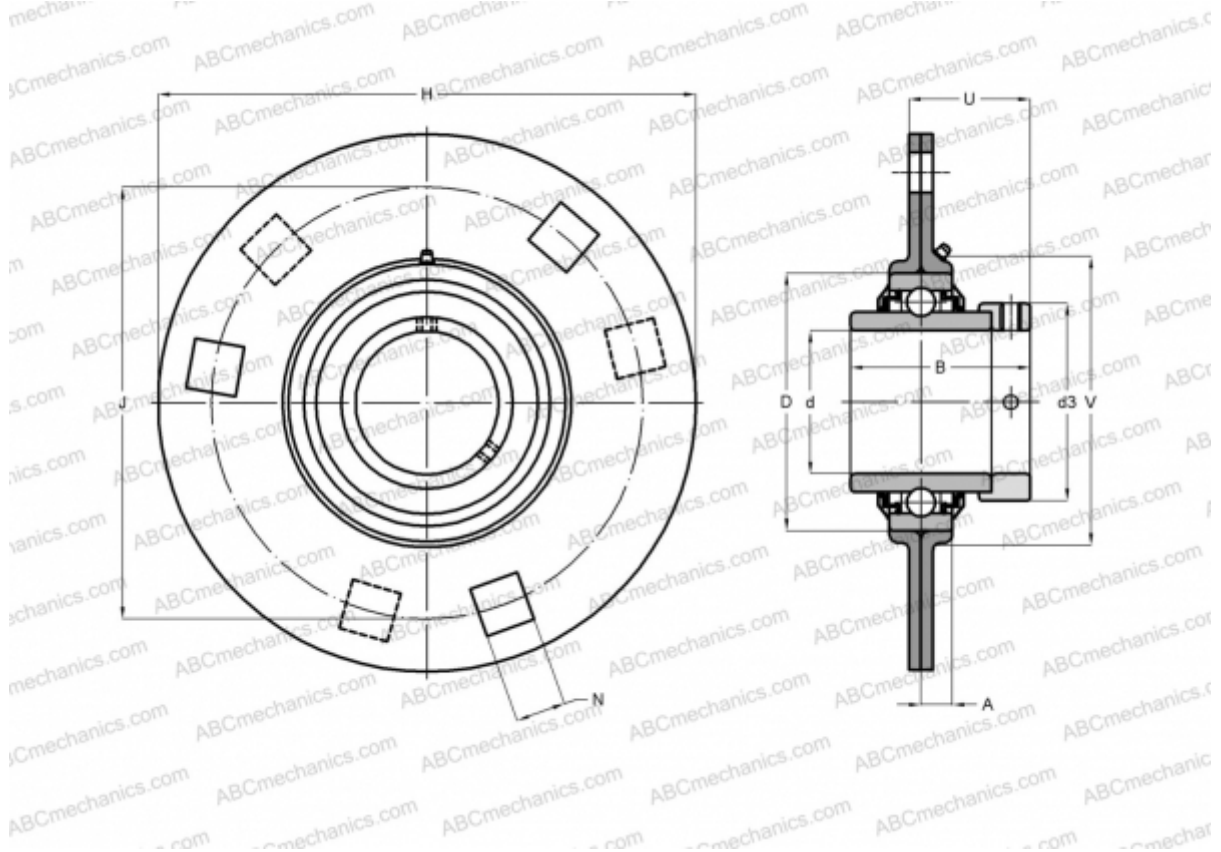

### Technical specification

#### DIMENSIONS, MM

d	25,000
D	52,000
B	34,000
H	95,000
A	8,700
J	76,000
N	8,700
U	21,700
V	60,000

**WEIGHT, KG** 0,380

Bearing	GYE25-KRR-B-
Housing	FLAN52-MSB-VA/FLAN52-MSA-VA x 1

#### MANUFACTURER

[INA](#)

#### CALCULATION DATA

Basic dynamic load rating, C	14,000 kN
Basic static load rating, Co	7,800 kN