

## PCJ20-N-FA125 INA

Ball bearing units

TYPE: Housing units, Four-bolt flanged housing units, Cast iron housing, Radial insert ball bearing with eccentric locking collar, Type PCJ (INA), coated with CORROTECT

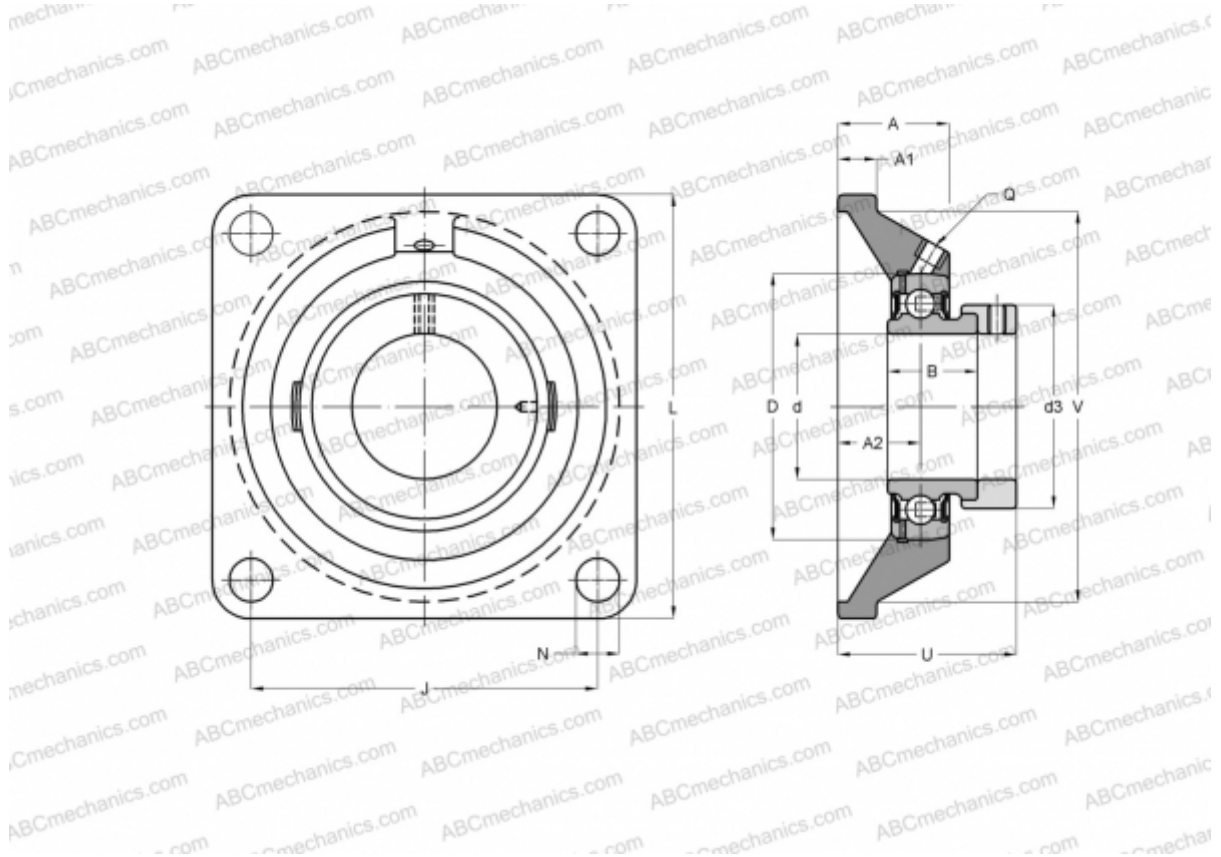

### Technical specification

#### DIMENSIONS, MM

d	20,000
D	47,000
B	31,000
L	86,000
A	29,000
J	63,500
A1	10,000
A2	19,000
N	11,500
d3	33,000
U	42,500
V	68,000
Q	Rp1/8

Bearing	GRAE20-NPP-B-
Housing	GG.CJ04-N-

FA125.1  
[INA](#)

#### MANUFACTURER

#### CALCULATION DATA

Basic dynamic load rating, C	12,800 kN
Basic static load rating, Co	6,600 kN

**WEIGHT, KG** 0,600