

PCJ50-N-FA125 INA

Ball bearing units

TYPE: Housing units, Four-bolt flanged housing units, Cast iron housing, Radial insert ball bearing with eccentric locking collar, Type PCJ (INA), coated with CORROTECT

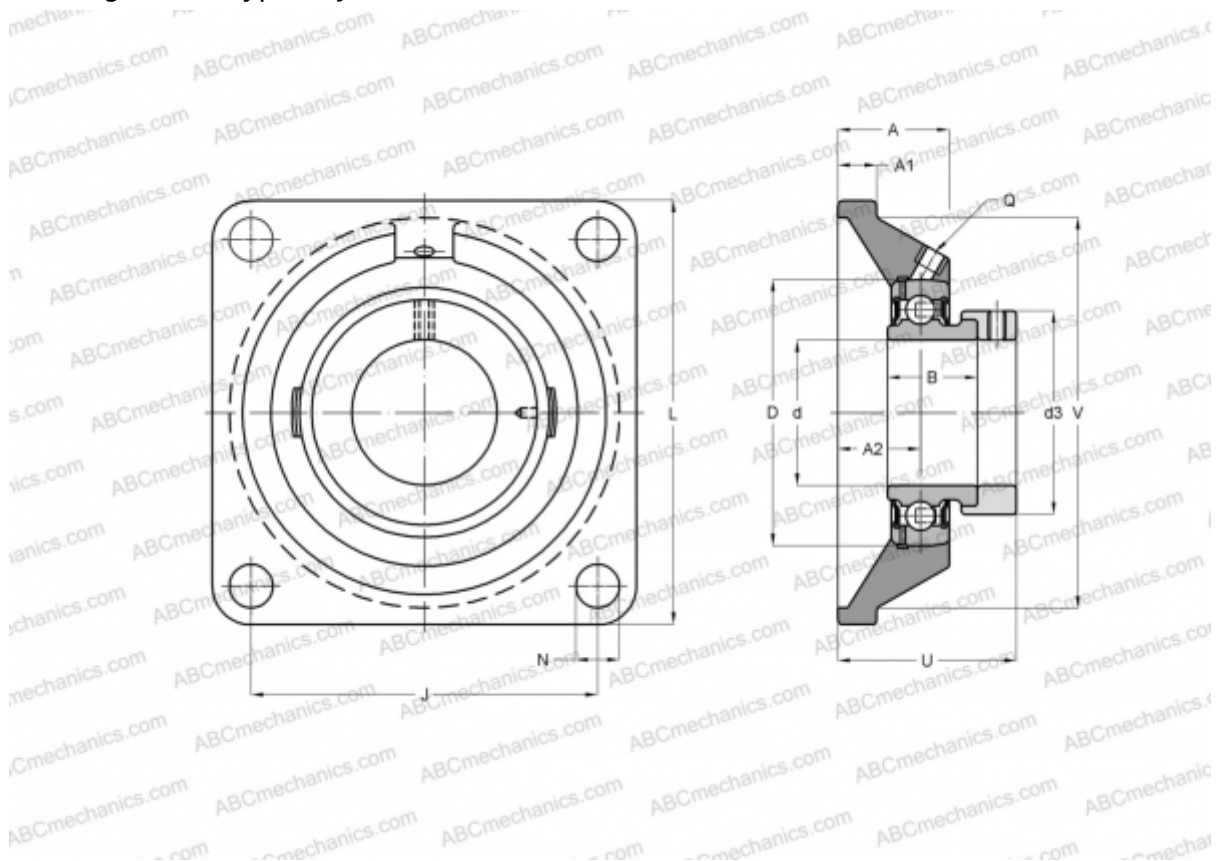

Technical specification

DIMENSIONS, MM

d	50,000
D	90,000
B	43,800
L	143,000
A	39,000
J	111,000
A1	13,000
A2	28,000
N	18,000
d3	69,000
U	60,800
V	125,000
Q	Rp1/8

Bearing	GRAE50-NPP-B-
Housing	GG.CJ10-N-

FA125.1

MANUFACTURER

[INA](#)

CALCULATION DATA

Basic dynamic load rating, C	35,000 kN
Basic static load rating, Co	23,200 kN

WEIGHT, KG 2,300