

RCJ55 INA

Ball bearing units

TYPE: Housing units, Four-bolt flanged housing units, Cast iron housing, Radial insert ball bearing with eccentric locking collar, Type RCJ (INA)

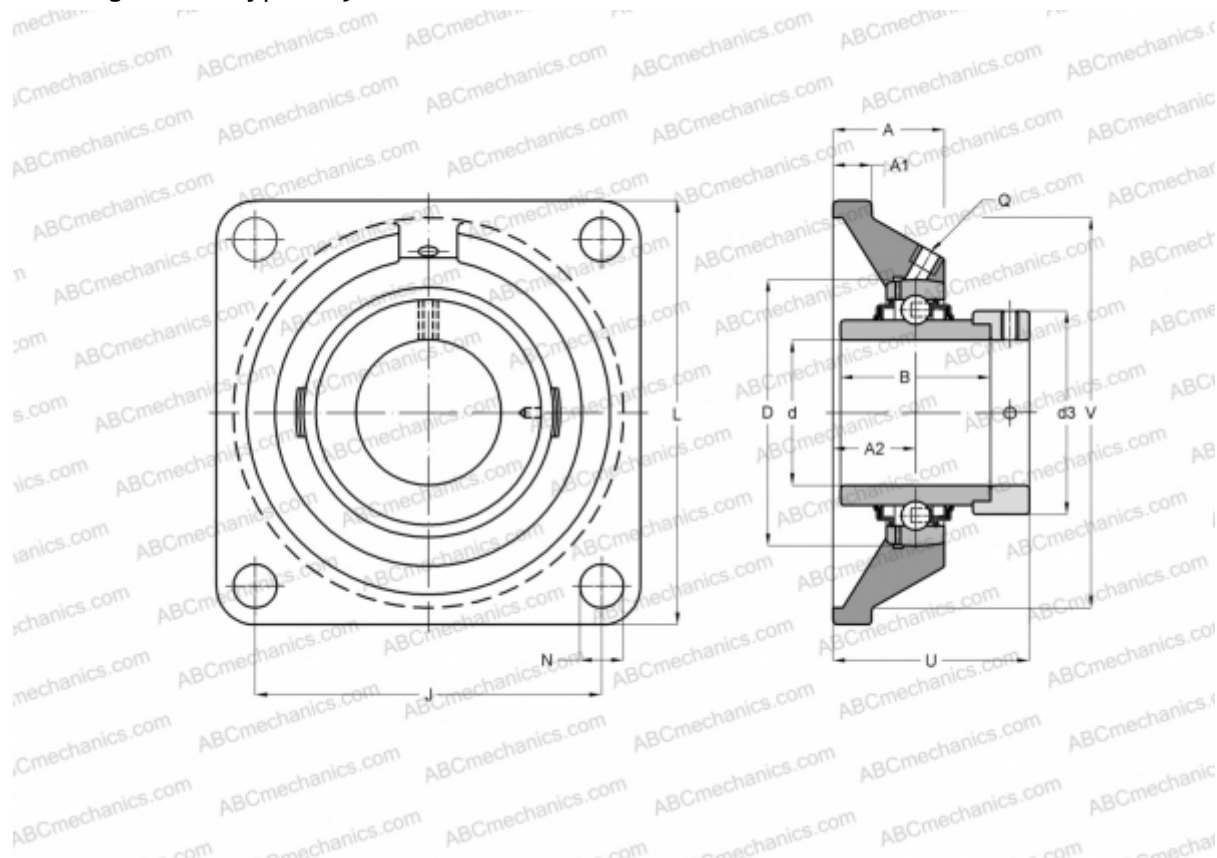

Technical specification

DIMENSIONS, MM

d	55,000
D	100,000
B	71,400
L	162,000
A	43,500
J	130,000
A1	15,000
A2	31,000
N	18,000
d3	76,000
U	74,600
V	140,000
Q	Rp1/8

Bearing	GE55-KRR-B
Housing	GG.CJ11

MANUFACTURER

[INA](#)

CALCULATION DATA

Basic dynamic load rating, C	43,500 kN
Basic static load rating, Co	29,000 kN

WEIGHT, KG 3,520