

RCJ100 INA

Ball bearing units

TYPE: Housing units, Four-bolt flanged housing units, Cast iron housing, Radial insert ball bearing with eccentric locking collar, Type RCJ (INA)

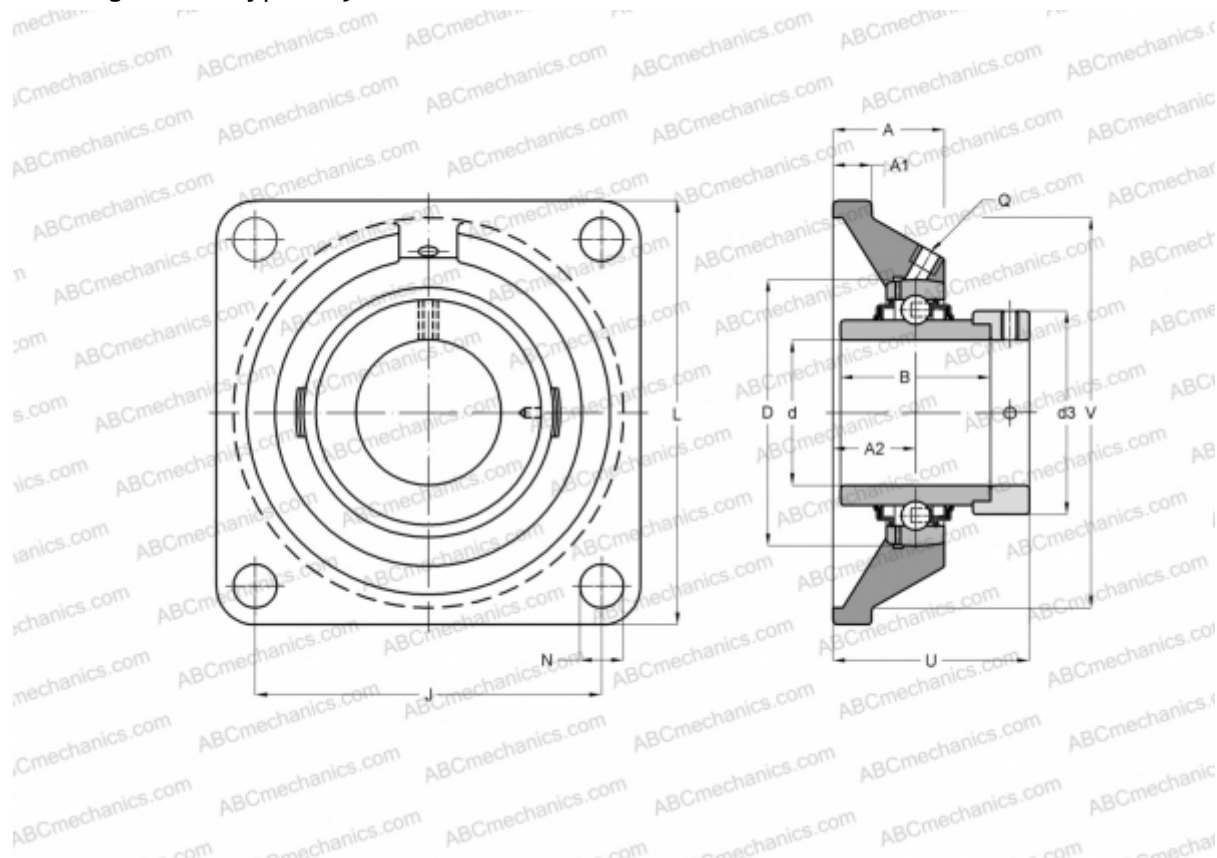

Technical specification

DIMENSIONS, MM

d	100,000
D	180,000
B	75,000
L	265,000
A	46,000
J	210,000
A1	25,000
A2	28,000
N	27,000
d3	132,000
U	77,500
V	230,000
Q	Rp1/8

Bearing	GE100-KRR-B
Housing	GG.CJ20

MANUFACTURER

[INA](#)

CALCULATION DATA

Basic dynamic load rating, C	122,000 kN
Basic static load rating, Co	93,000 kN

WEIGHT, KG 12,250