

RCJ25-FA164 INA

Ball bearing units

TYPE: Housing units, Four-bolt flanged housing units, Cast iron housing, Radial insert ball bearing with eccentric locking collar, Type RCJ (INA), for high temperatures (+250)

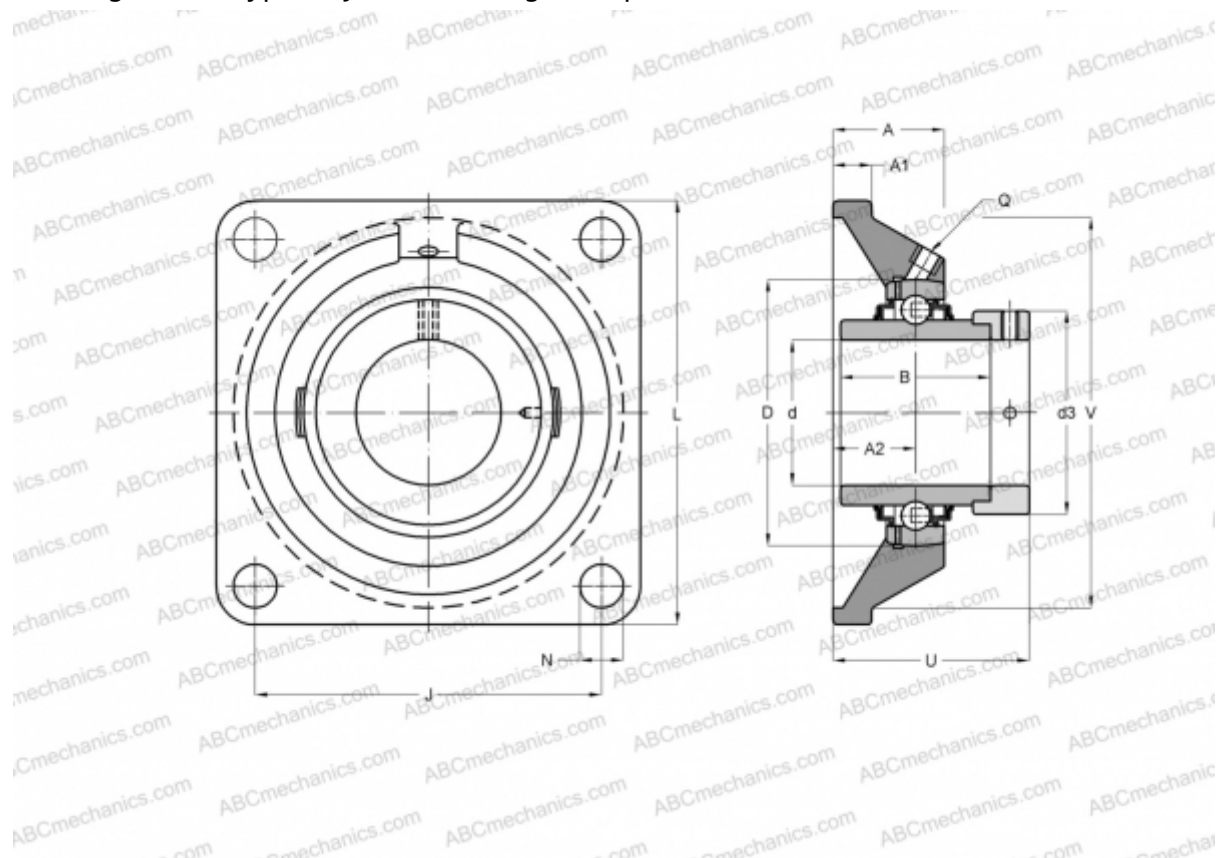

Technical specification

DIMENSIONS, MM

d	25,000
D	52,000
B	44,500
L	95,000
A	29,000
J	70,000
A1	11,000
A2	19,000
N	11,500
d3	37,500
U	46,000
V	74,000
Q	Rp1/8

Bearing	GE25-KRR-B-
Housing	GG.CJ05-N

MANUFACTURER

[INA](#)

CALCULATION DATA

Basic dynamic load rating, C	14,000 kN
Basic static load rating, Co	7,800 kN
Operating temperature max	250 °C

WEIGHT, KG 0,820