

RCJO30 INA

Ball bearing units

TYPE: Housing units, Four-bolt flanged housing units, Cast iron housing, Radial insert ball bearing with eccentric locking collar, Type RCJO (INA)

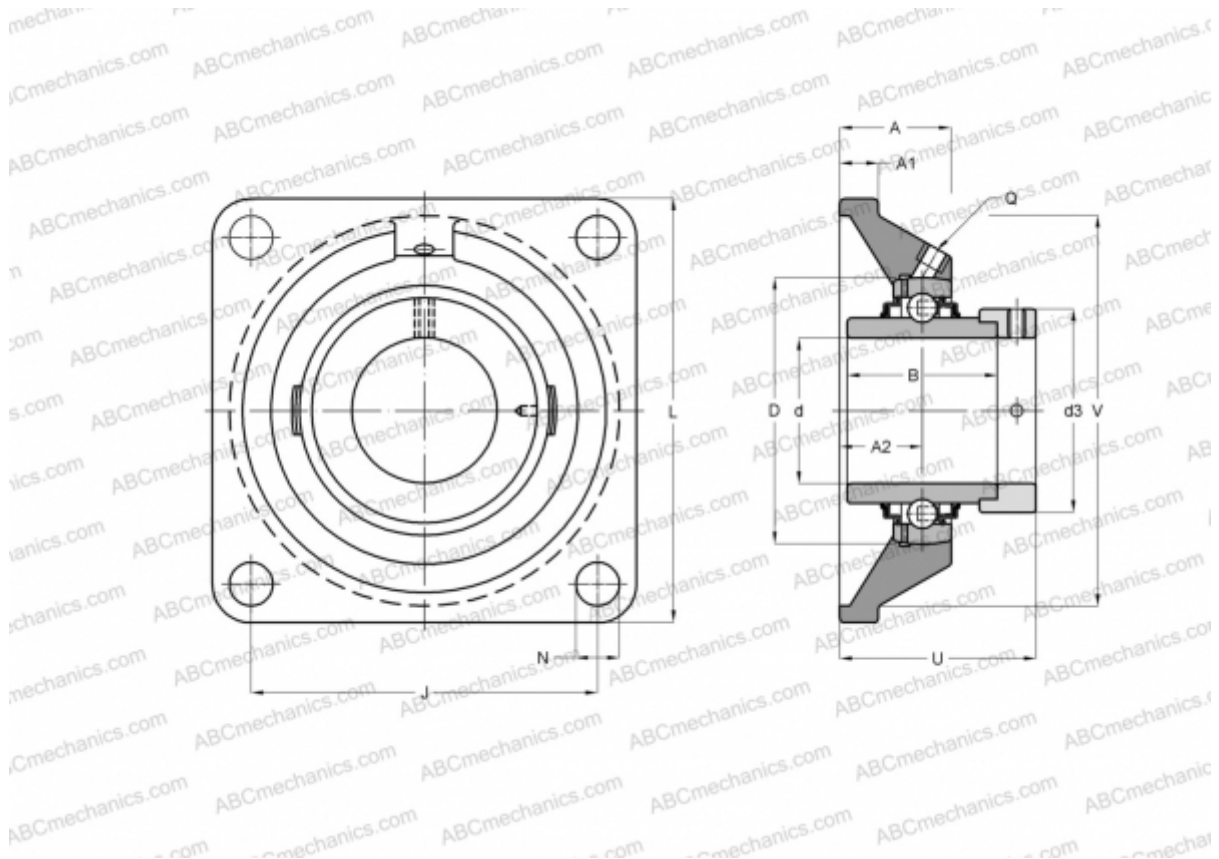

Technical specification

DIMENSIONS, MM

d	30,000
D	72,000
B	50,000
L	125,000
A	30,600
J	95,000
A1	15,000
A2	20,600
N	14,500
d3	51,000
U	53,100
V	98,000
Q	Rp1/8

Bearing	GNE30-KRR-B
Housing	GG.CJO06

MANUFACTURER

[INA](#)

CALCULATION DATA

Basic dynamic load rating, C	29,500 kN
Basic static load rating, Co	16,700 kN

WEIGHT, KG 1,750