

RCJO80 INA

Ball bearing units

TYPE: Housing units, Four-bolt flanged housing units, Cast iron housing, Radial insert ball bearing with eccentric locking collar, Type RCJO (INA)

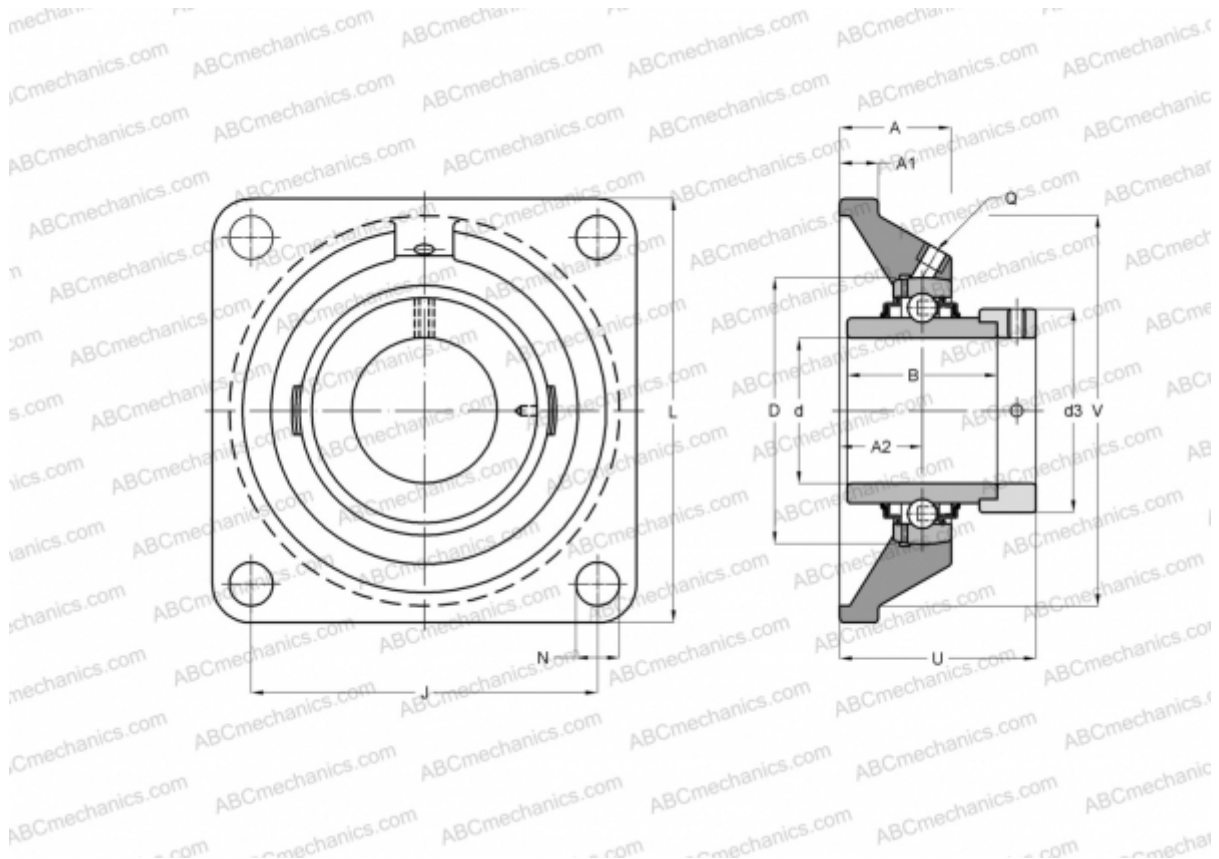

Technical specification

DIMENSIONS, MM

d	80,000
D	170,000
B	93,600
L	250,000
A	80,000
J	196,000
A1	25,000
A2	50,000
N	28,000
d3	118,000
U	109,700
V	210,000
Q	Rp1/8

Bearing	GNE80-KRR-B
Housing	GG.CJO16

MANUFACTURER

[INA](#)

CALCULATION DATA

Basic dynamic load rating, C	123,000 kN
Basic static load rating, Co	87,000 kN

WEIGHT, KG 17,150