

TCJ35-N INA

Ball bearing units

TYPE: Housing units, Four-bolt flanged housing units, Cast iron housing, Radial insert ball bearing with eccentric locking collar, Type TCJ (INA)

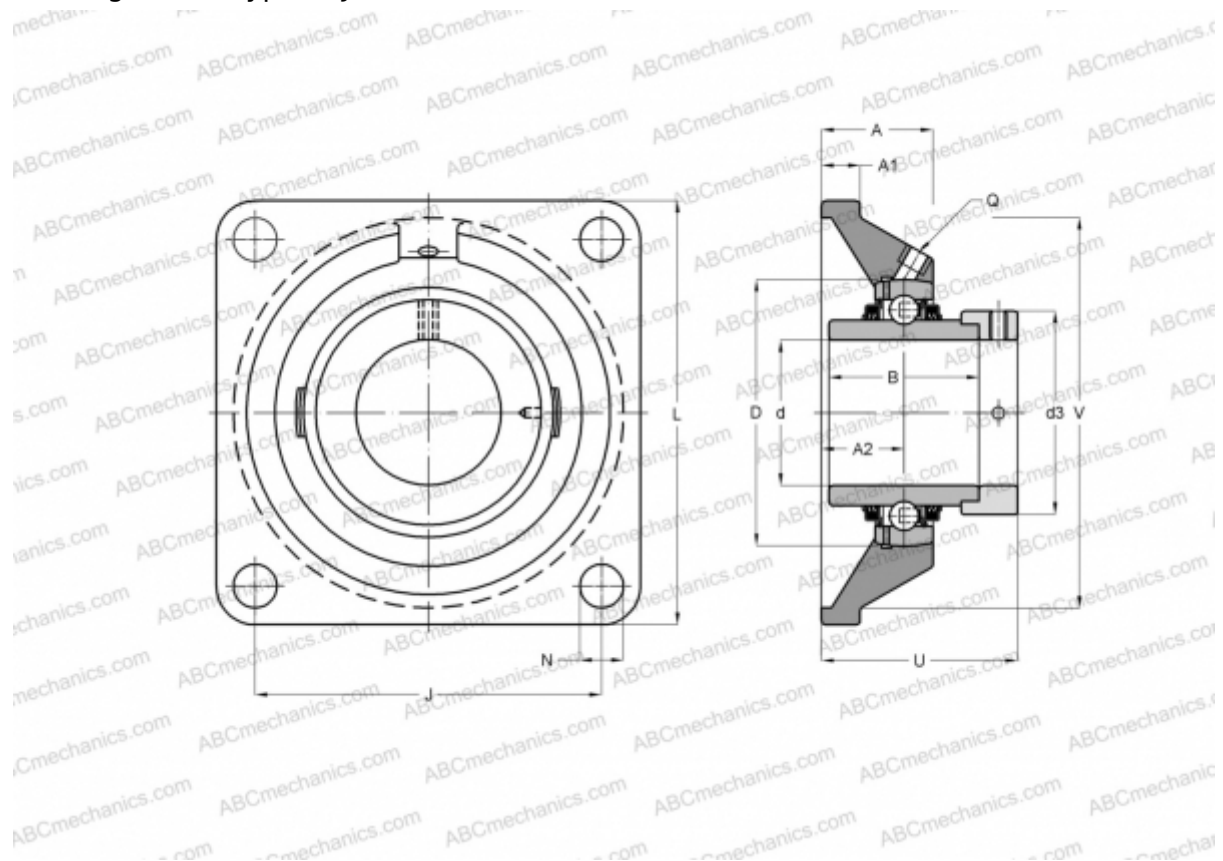

Technical specification

DIMENSIONS, MM

d	35,000
D	72,000
B	51,300
L	118,000
A	30,500
J	92,000
A1	12,500
A2	21,000
N	14,000
d3	51,000
U	53,500
V	100,000
Q	Rp1/8

WEIGHT, KG 1,540

Bearing	GE35-KTT-B
Housing	GG.CJ07-N

MANUFACTURER

[INA](#)

CALCULATION DATA

Basic dynamic load rating, C	25,500 kN
Basic static load rating, Co	15,300 kN