

TCJ45 INA

Ball bearing units

TYPE: Housing units, Four-bolt flanged housing units, Cast iron housing, Radial insert ball bearing with eccentric locking collar, Type TCJ (INA)

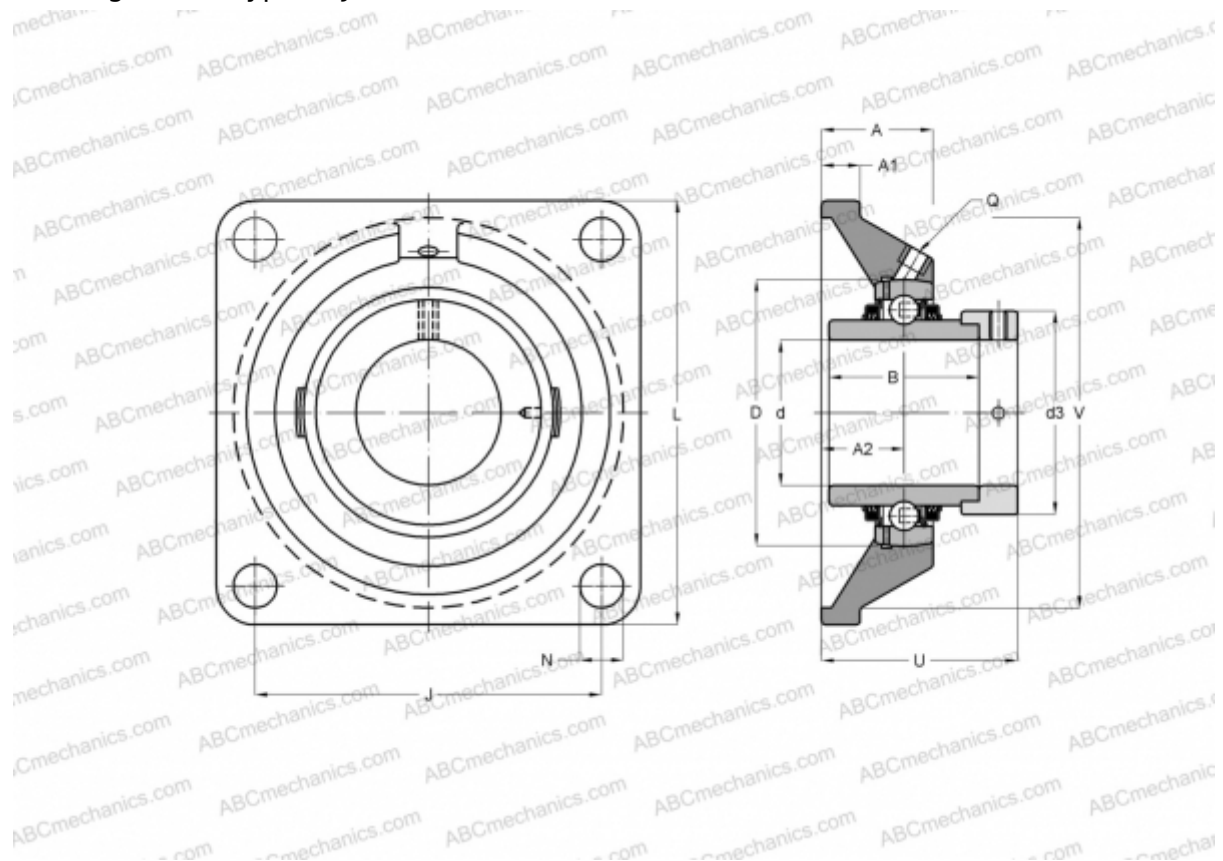

Technical specification

DIMENSIONS, MM

d	45,000
D	85,000
B	56,500
L	137,000
A	35,000
J	105,000
A1	13,000
A2	24,000
N	14,000
d3	63,000
U	59,100
V	116,000
Q	Rp1/8

WEIGHT, KG 2,370

Bearing	GE45-KTT-B
Housing	GG.CJ09

MANUFACTURER

[INA](#)

CALCULATION DATA

Basic dynamic load rating, C	32,500 kN
Basic static load rating, Co	20,400 kN