

TCJ50-N INA

Ball bearing units

TYPE: Housing units, Four-bolt flanged housing units, Cast iron housing, Radial insert ball bearing with eccentric locking collar, Type TCJ (INA)

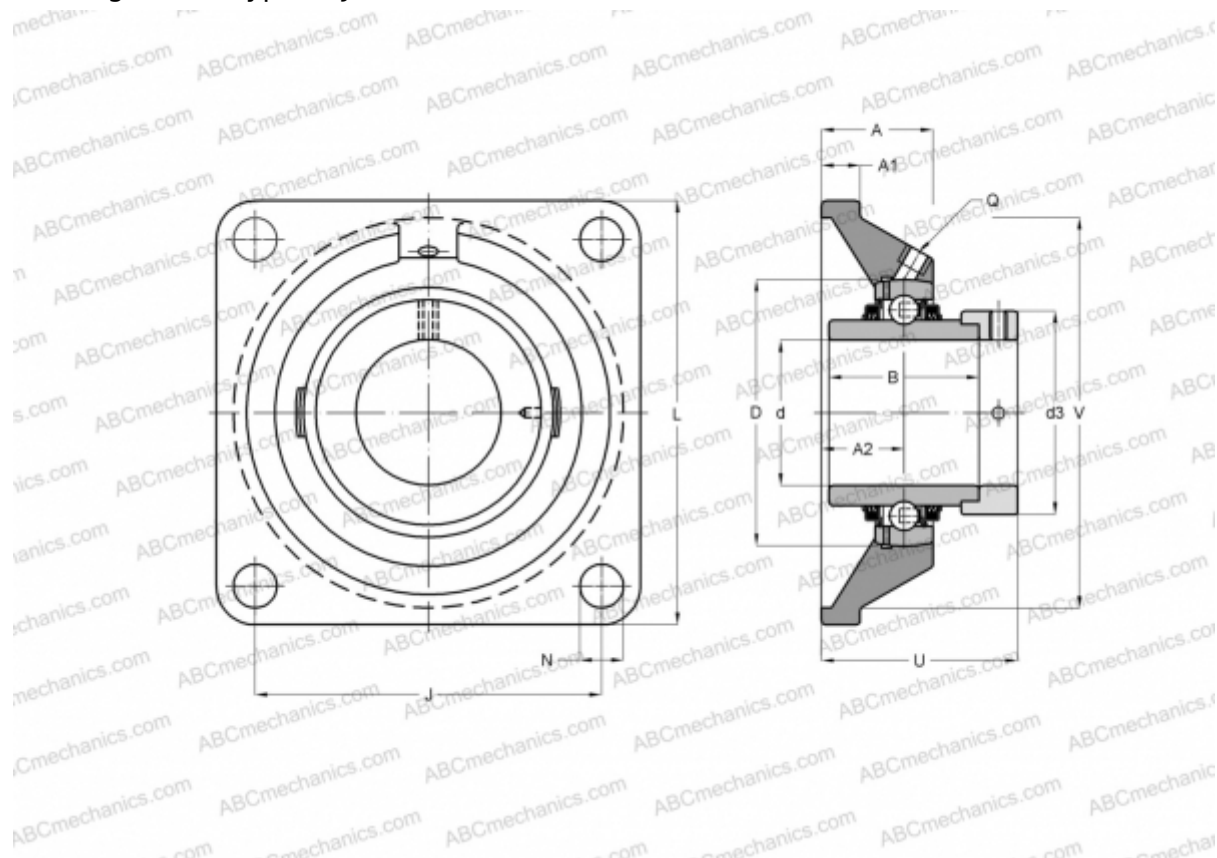

Technical specification

DIMENSIONS, MM

d	50,000
D	90,000
B	62,800
L	143,000
A	39,000
J	111,000
A1	13,000
A2	28,000
N	18,000
d3	69,000
U	66,100
V	125,000
Q	Rp1/8

WEIGHT, KG 2,530

Bearing	GE50-KTT-B
Housing	GG.CJ10-N

MANUFACTURER

[INA](#)

CALCULATION DATA

Basic dynamic load rating, C	35,000 kN
Basic static load rating, Co	23,200 kN