

PCF20 INA

Ball bearing units

TYPE: Housing units, Four-bolt flanged housing units, Cast iron housing, Radial insert ball bearing with eccentric locking collar, Type PCF (INA)

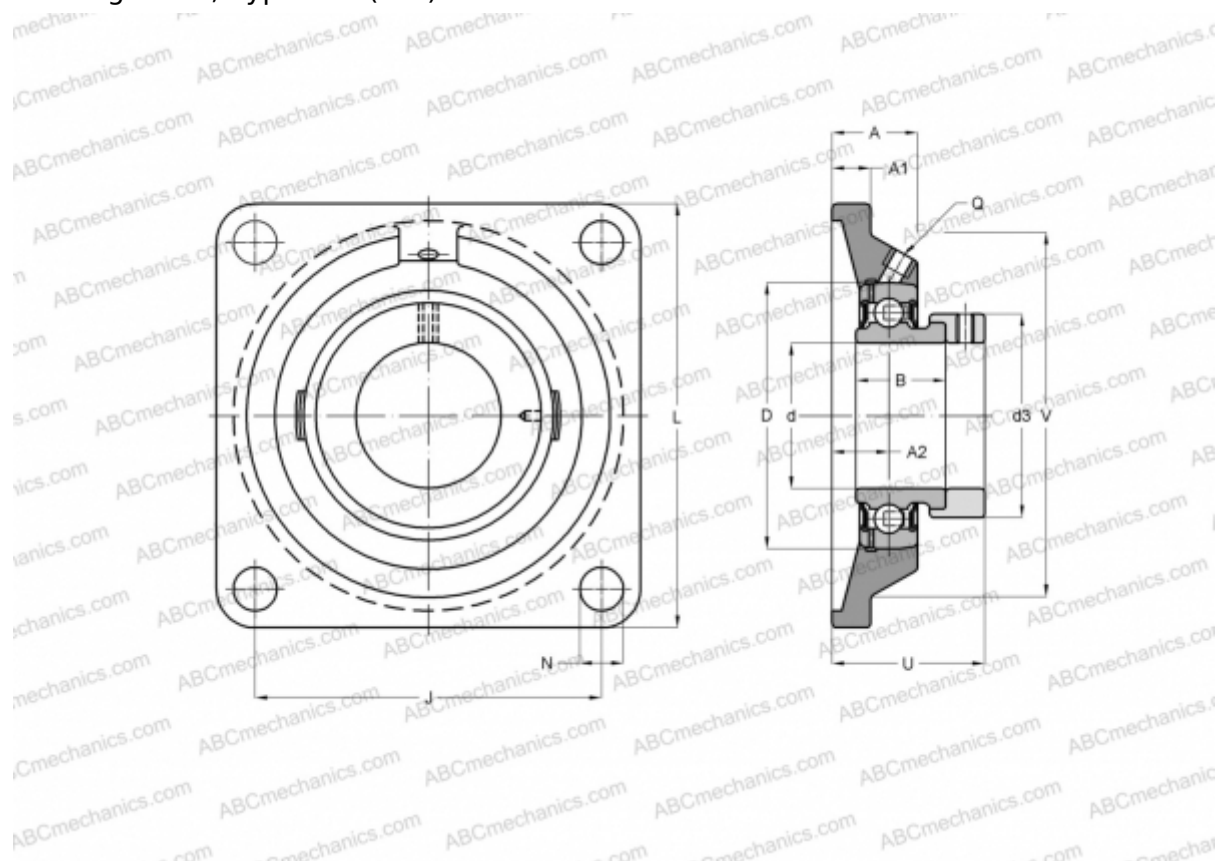

Technical specification

DIMENSIONS, MM

d	20,000
D	47,000
B	31,000
L	86,000
A	20,000
J	63,500
A1	10,000
A2	10,500
N	11,500
d3	33,000
U	34,000
V	68,000
Q	Rp1/8

Bearing	GRAE20-NPP-B
Housing	GG.CF04

MANUFACTURER

[INA](#)

CALCULATION DATA

Basic dynamic load rating, C	12,800 kN
Basic static load rating, Co	6,600 kN

WEIGHT, KG 0,550