

PME45 INA

Ball bearing units

TYPE: Housing units, Four-bolt flanged housing units, Cast iron housing, Radial insert ball bearing with eccentric locking collar, Centring spigot, type PME (INA)

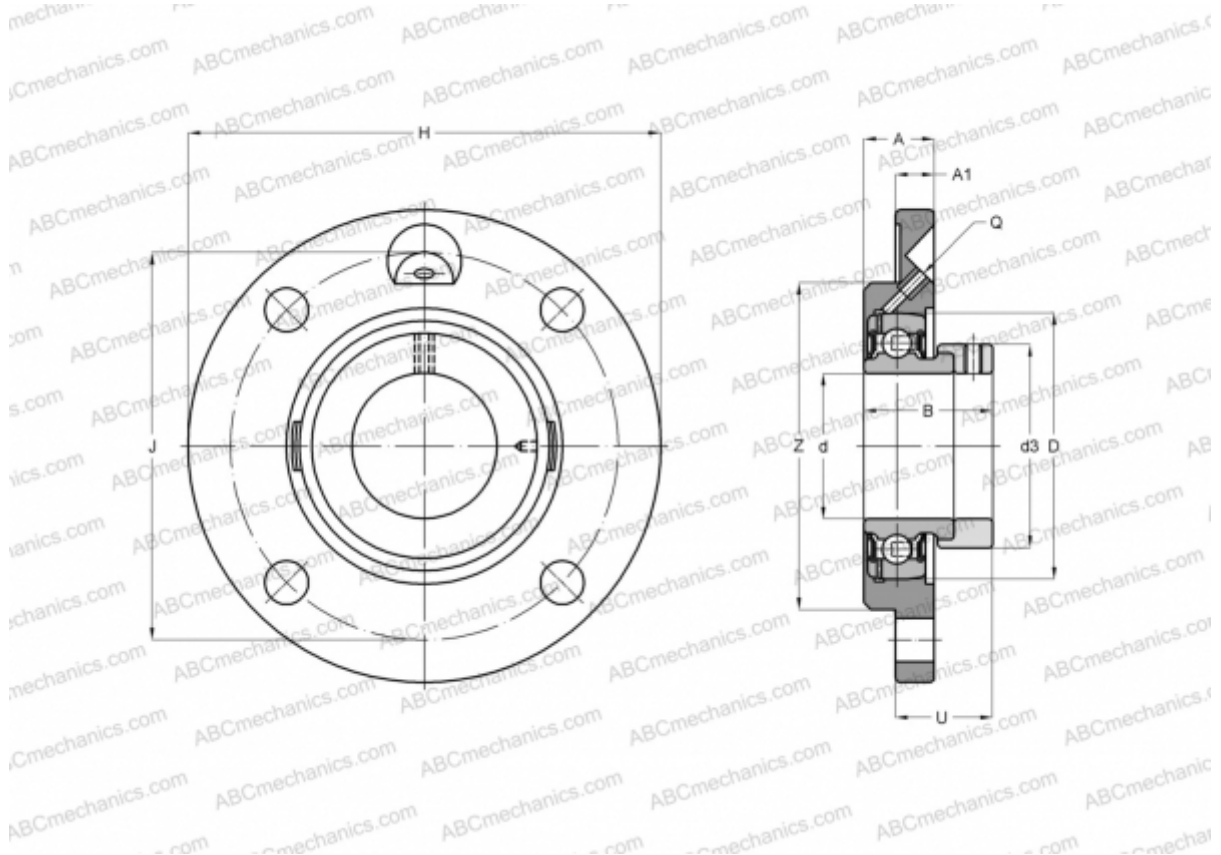

Technical specification

DIMENSIONS, MM

d	45,000
D	85,000
B	43,800
H	155,000
A	25,000
J	130,000
A1	12,000
N	14,000
d3	63,000
U	30,700
Z	105,000
Q	M6

WEIGHT, KG 1,930

Bearing	GRAE45-NPP-B
Housing	GG.ME09

MANUFACTURER

[INA](#)

CALCULATION DATA

Basic dynamic load rating, C	32,500 kN
Basic static load rating, Co	20,400 kN