

## RME25-N INA

Ball bearing units

TYPE: Housing units, Four-bolt flanged housing units, Cast iron housing, Radial insert ball bearing with eccentric locking collar, Centring spigot, type RME (INA)

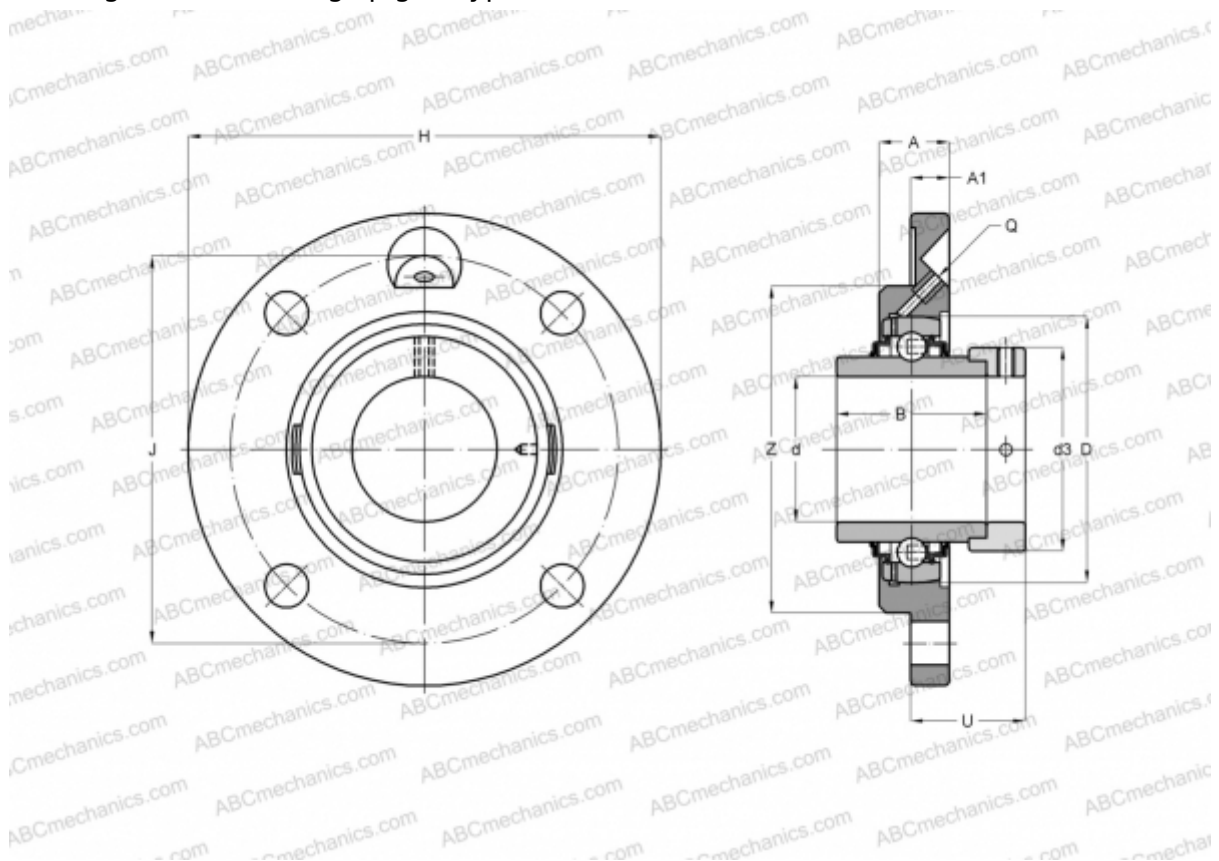

### Technical specification

#### DIMENSIONS, MM

d	25,000
D	52,000
B	44,500
H	115,000
A	19,000
J	90,000
A1	9,000
N	9,000
d3	37,500
U	24,400
Z	70,000
Q	M6

**WEIGHT, KG** 0,800

Bearing	GE25-KRR-B
Housing	GG.ME05-N
Protective cover	KASK05

#### MANUFACTURER

[INA](#)

#### CALCULATION DATA

Basic dynamic load rating, C	14,000 kN
Basic static load rating, Co	7,800 kN