

## RME30-N INA

Ball bearing units

TYPE: Housing units, Four-bolt flanged housing units, Cast iron housing, Radial insert ball bearing with eccentric locking collar, Centring spigot, type RME (INA)

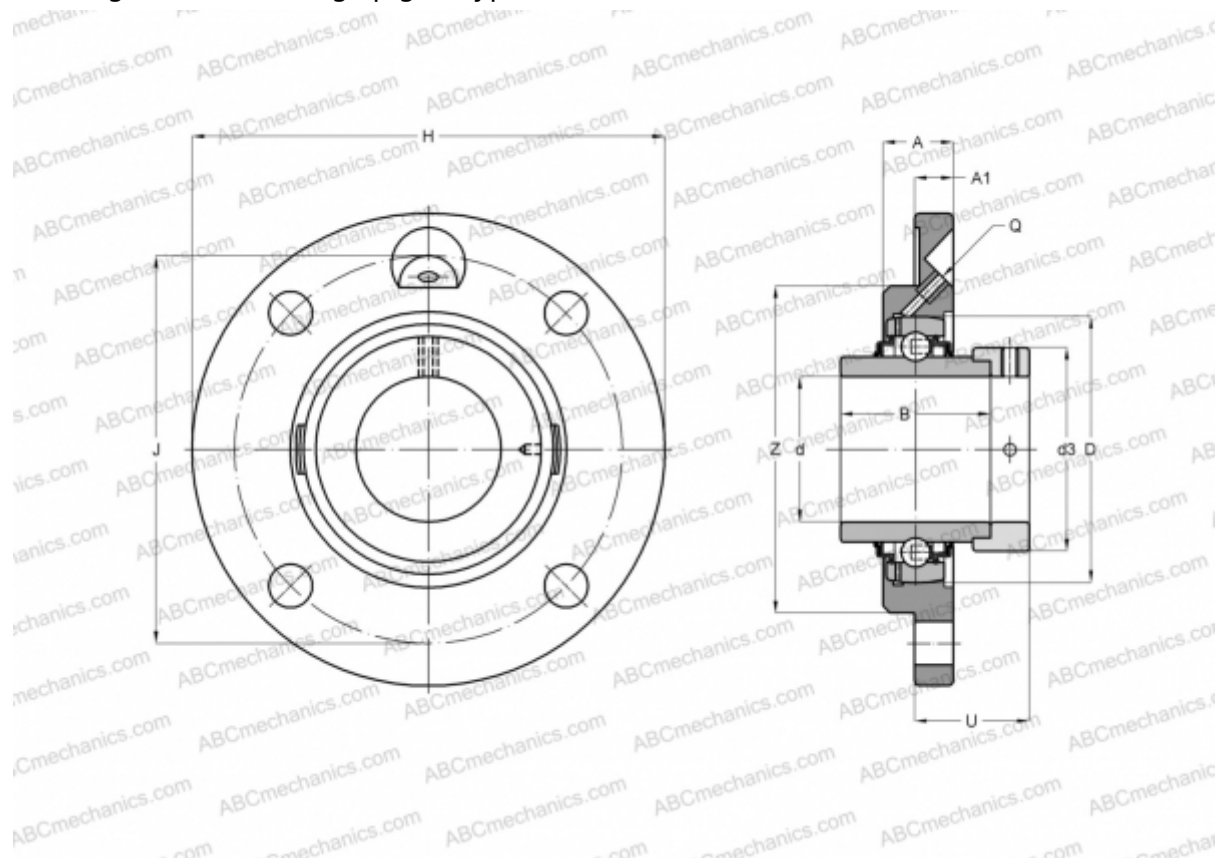

### Technical specification

#### DIMENSIONS, MM

d	30,000
D	62,000
B	48,500
H	125,000
A	20,500
J	100,000
A1	9,500
N	11,500
d3	44,000
U	28,100
Z	80,000
Q	M6

**WEIGHT, KG** 1,040

Bearing	GE30-KRR-B
Housing	GG.ME06-N
Protective cover	KASK06

#### MANUFACTURER

[INA](#)

#### CALCULATION DATA

Basic dynamic load rating, C	19,500 kN
Basic static load rating, Co	11,300 kN