

RME70 INA

Ball bearing units

TYPE: Housing units, Four-bolt flanged housing units, Cast iron housing, Radial insert ball bearing with eccentric locking collar, Centring spigot, type RME (INA)

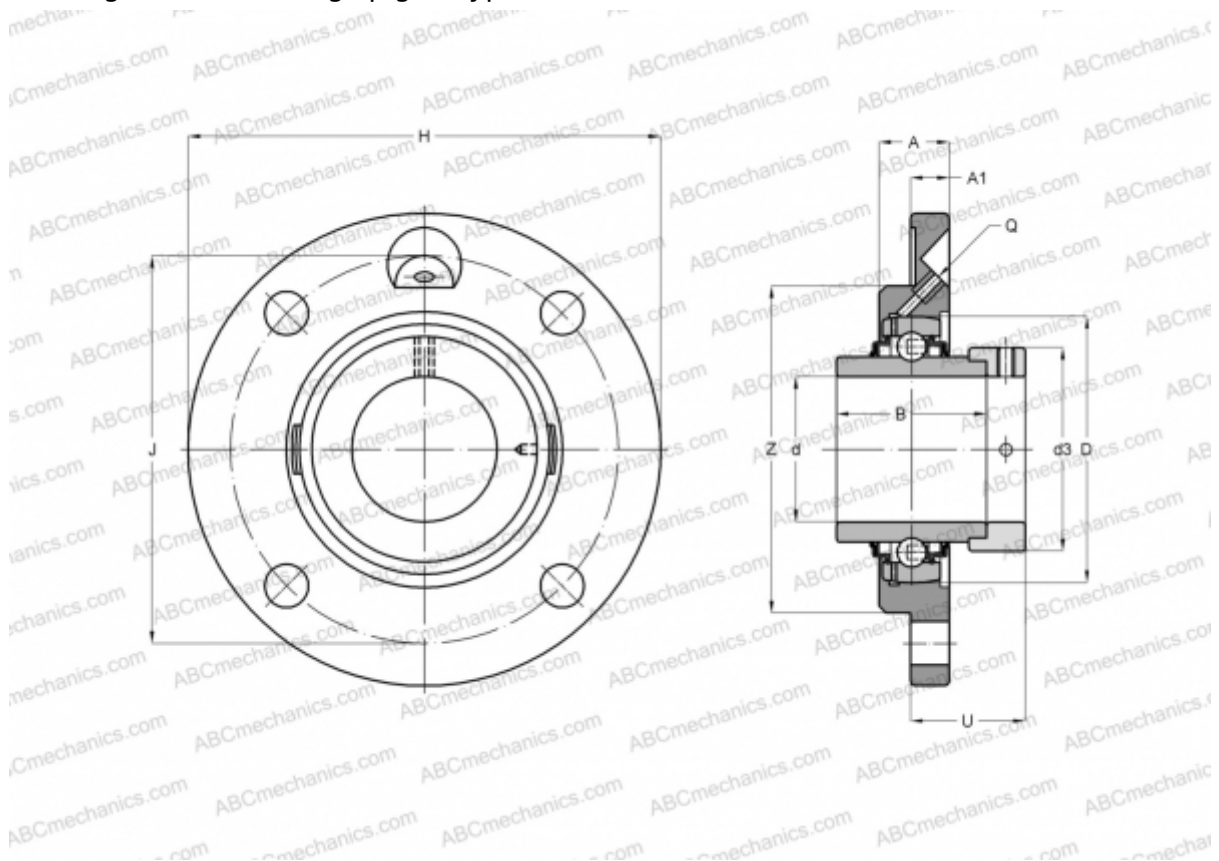

Technical specification

DIMENSIONS, MM

d	70,000
D	125,000
B	66,000
H	215,000
A	32,000
J	177,000
A1	18,000
N	18,000
d3	96,000
U	44,500
Z	150,000
Q	Rp1/8

WEIGHT, KG 5,550

Bearing	GE70-KRR-B
Housing	GG.ME14

MANUFACTURER

[INA](#)

CALCULATION DATA

Basic dynamic load rating, C	62,000 kN
Basic static load rating, Co	44,000 kN