

RME90 INA

Ball bearing units

TYPE: Housing units, Four-bolt flanged housing units, Cast iron housing, Radial insert ball bearing with eccentric locking collar, Centring spigot, type RME (INA)

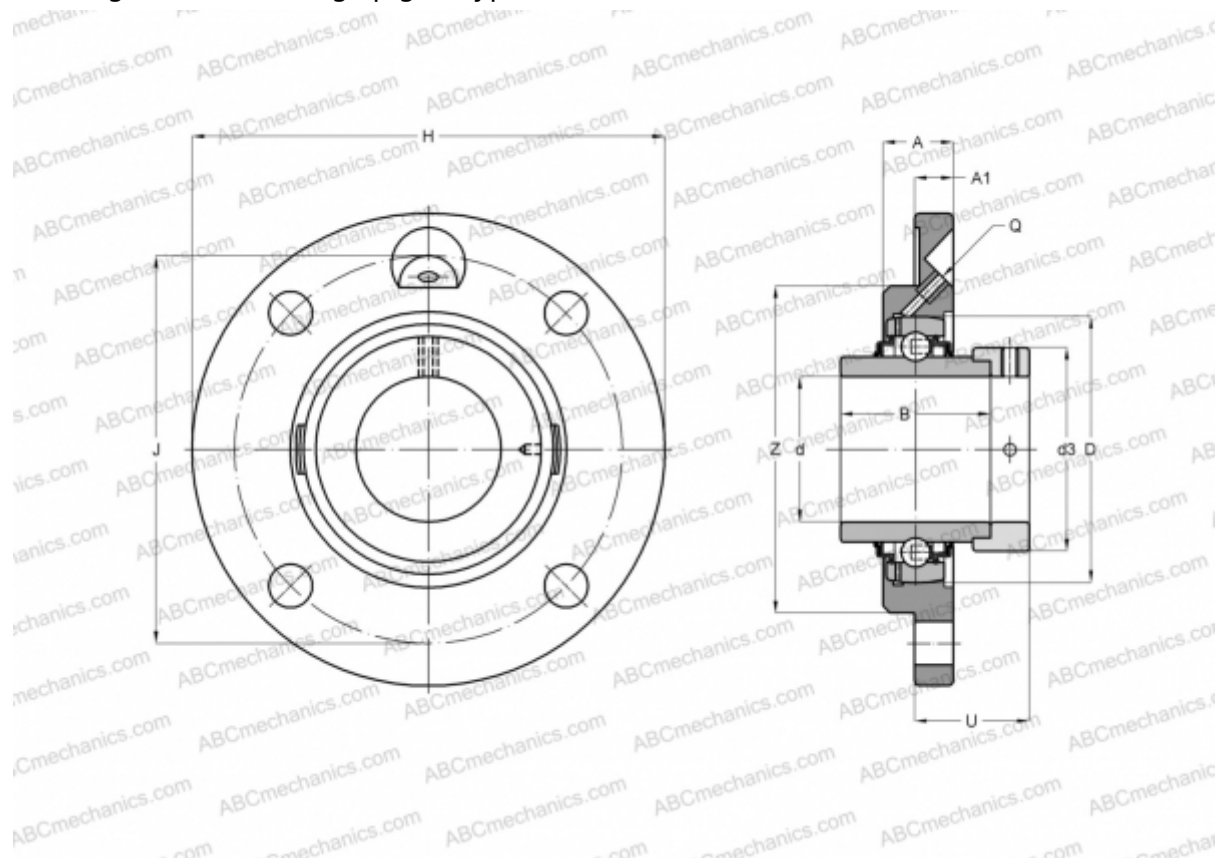

Technical specification

DIMENSIONS, MM

d	90,000
D	160,000
B	69,500
H	265,000
A	32,000
J	220,000
A1	20,000
N	23,000
d3	118,000
U	50,500
Z	190,000
Q	Rp1/8

WEIGHT, KG 8,500

Bearing	GE90-KRR-B
Housing	GG.ME18

MANUFACTURER

[INA](#)

CALCULATION DATA

Basic dynamic load rating, C	96,000 kN
Basic static load rating, Co	72,000 kN