

RME100 INA

Ball bearing units

TYPE: Housing units, Four-bolt flanged housing units, Cast iron housing, Radial insert ball bearing with eccentric locking collar, Centring spigot, type RME (INA)

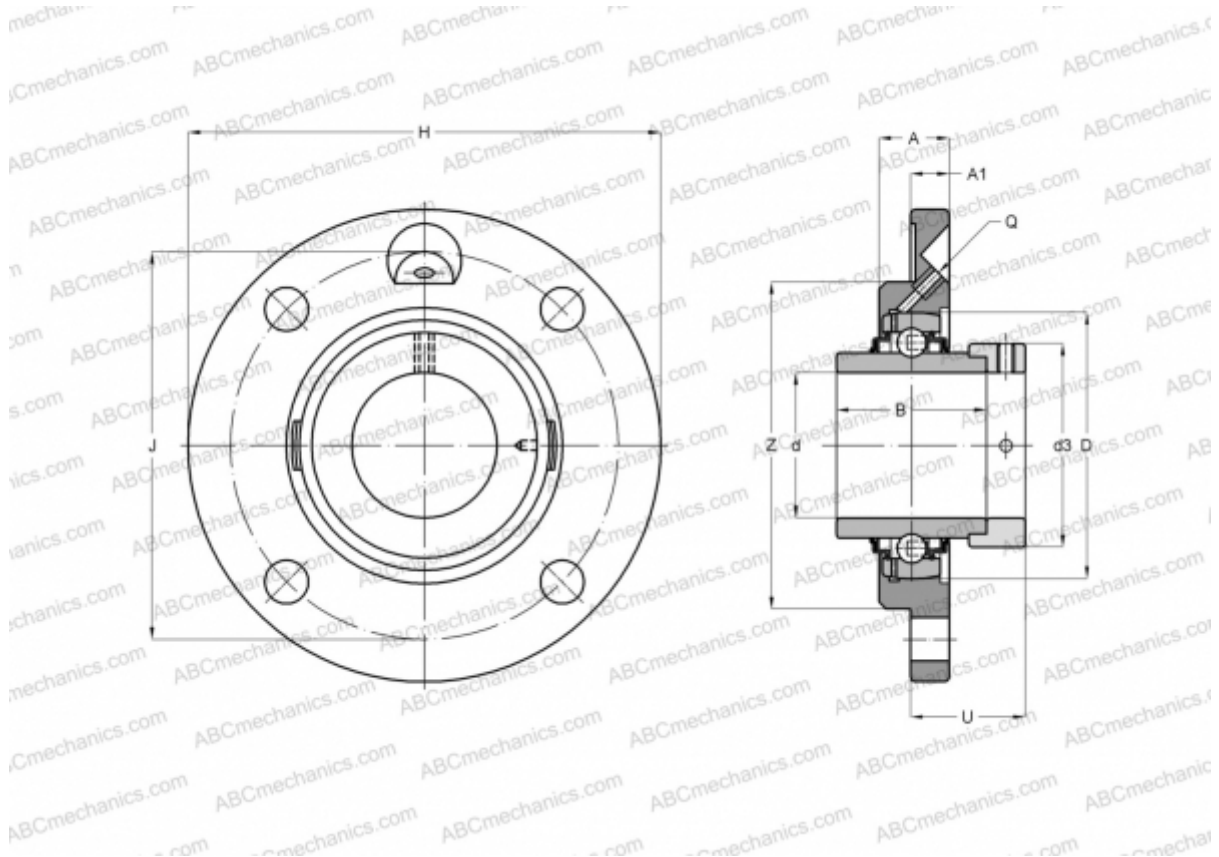

Technical specification

DIMENSIONS, MM

d	100,000
D	180,000
B	75,000
H	295,000
A	36,000
J	245,000
A1	22,000
N	23,000
d3	132,000
U	53,400
Z	210,000
Q	Rp1/8

WEIGHT, KG 11,450

Bearing	GE100-KRR-B
Housing	GG.ME20

MANUFACTURER

[INA](#)

CALCULATION DATA

Basic dynamic load rating, C	122,000 kN
Basic static load rating, Co	93,000 kN