

TME20-N INA

Ball bearing units

TYPE: Housing units, Four-bolt flanged housing units, Cast iron housing, Radial insert ball bearing with eccentric locking collar, Centring spigot, type TME (INA)

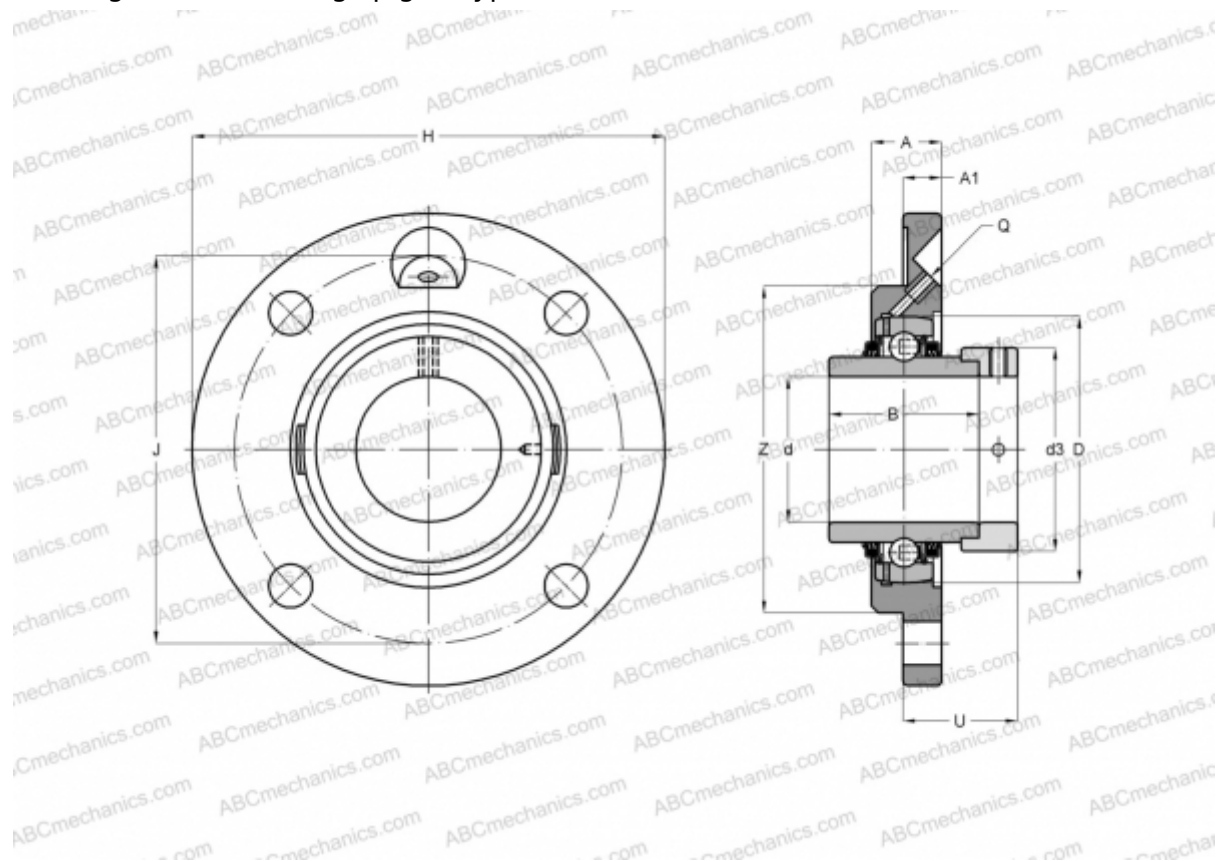

Technical specification

DIMENSIONS, MM

d	20,000
D	47,000
B	43,700
H	100,000
A	17,000
J	78,000
A1	8,000
N	9,000
d3	33,000
U	24,600
Z	62,000
Q	M6

WEIGHT, KG 0,560

Bearing	GE20-KTT-B
Housing	GG.ME04-N
Protective cover	KASK04

MANUFACTURER

[INA](#)

CALCULATION DATA

Basic dynamic load rating, C	12,800 kN
Basic static load rating, Co	6,600 kN