

TME75 INA

Ball bearing units

TYPE: Housing units, Four-bolt flanged housing units, Cast iron housing, Radial insert ball bearing with eccentric locking collar, Centring spigot, type TME (INA)

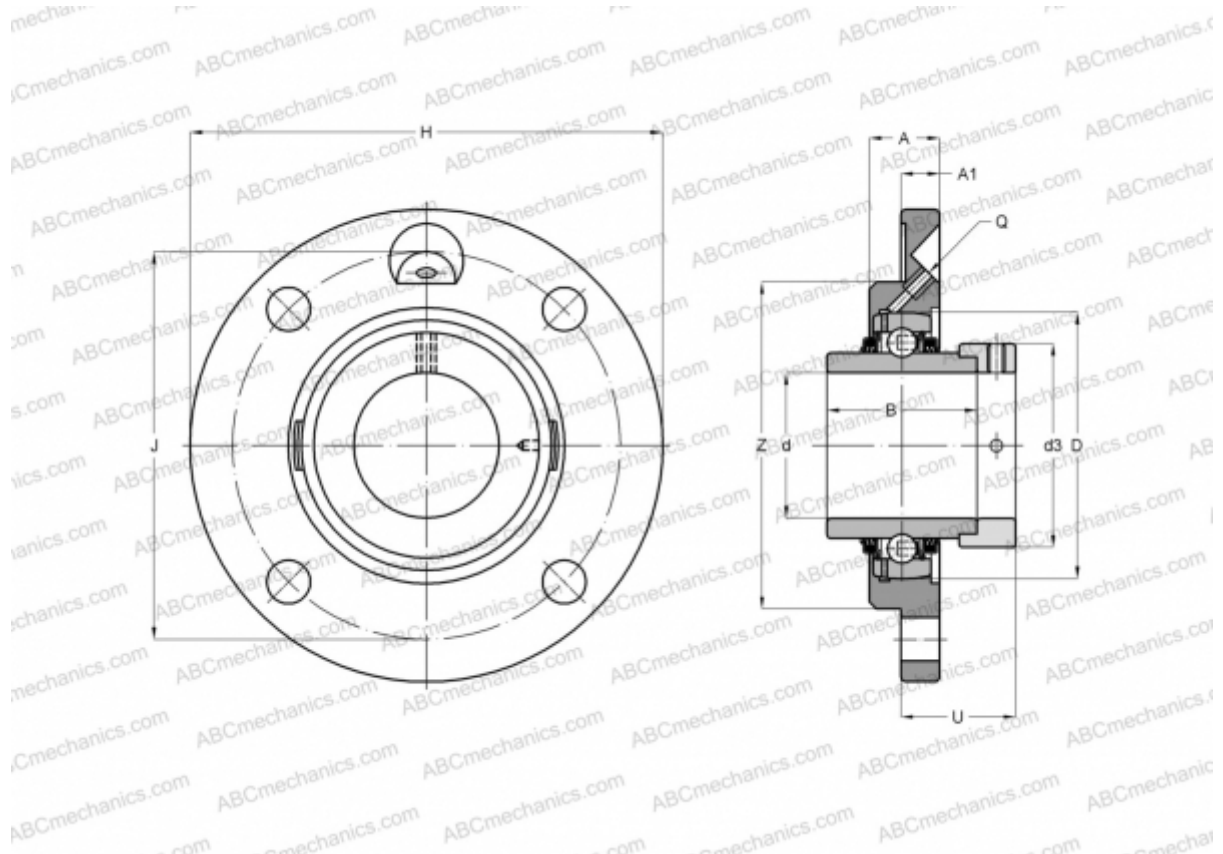

Technical specification

DIMENSIONS, MM

d	75,000
D	130,000
B	67,000
H	220,000
A	32,000
J	184,000
A1	18,000
N	18,000
d3	100,000
U	45,600
Z	160,000
Q	Rp1/8

WEIGHT, KG 5,760

Bearing	GE75-KTT-B
Housing	GG.ME15

MANUFACTURER [INA](#)

CALCULATION DATA

Basic dynamic load rating, C	62,000 kN
Basic static load rating, Co	44,500 kN