

TME80 INA

Ball bearing units

TYPE: Housing units, Four-bolt flanged housing units, Cast iron housing, Radial insert ball bearing with eccentric locking collar, Centring spigot, type TME (INA)

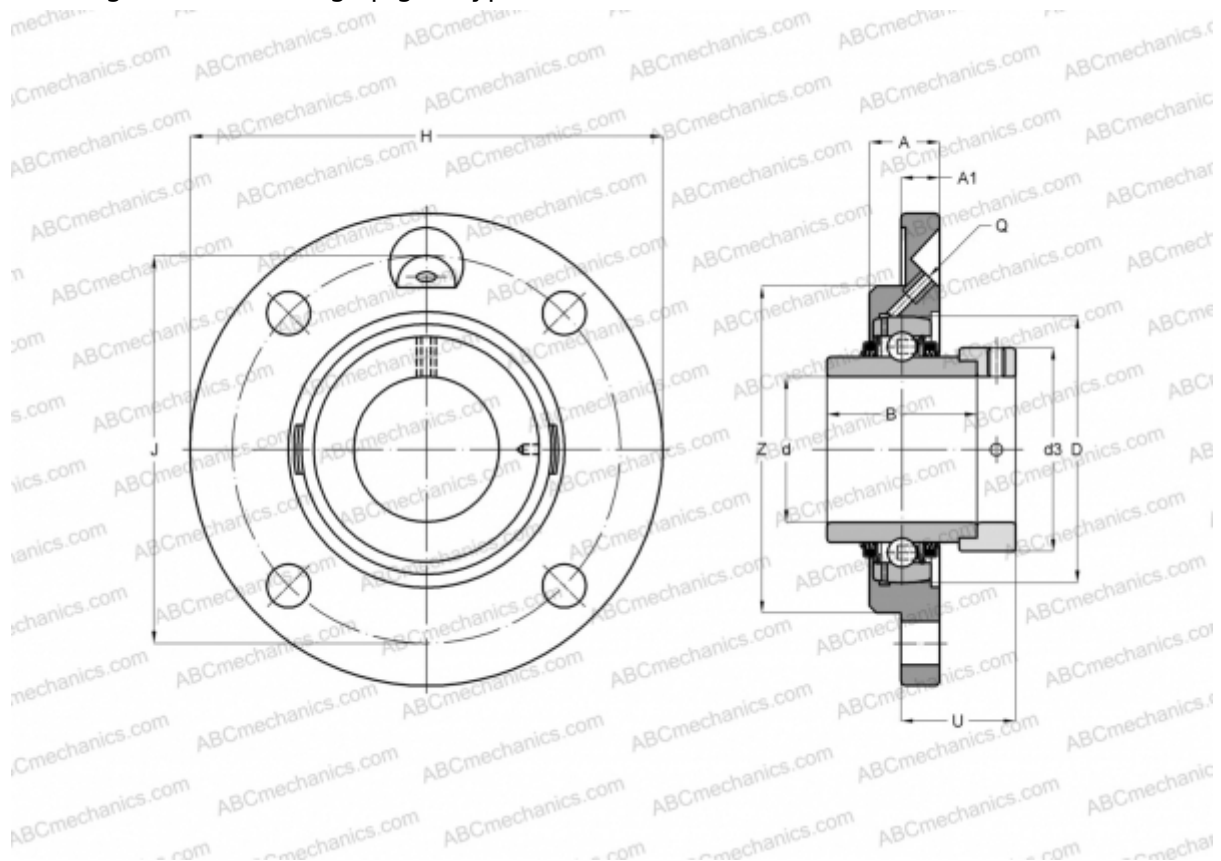

Technical specification

DIMENSIONS, MM

d	80,000
D	140,000
B	70,700
H	220,000
A	31,000
J	184,000
A1	18,000
N	18,000
d3	108,000
U	49,300
Z	160,000
Q	Rp1/8

WEIGHT, KG 5,510

Bearing	GE80-KTT-B
Housing	GG.ME16

MANUFACTURER

[INA](#)

CALCULATION DATA

Basic dynamic load rating, C	72,000 kN
Basic static load rating, Co	54,000 kN