

RFE25 INA

Ball bearing units

TYPE: Housing units, Four-bolt flanged housing units, Cast iron housing, Radial insert ball bearing with eccentric locking collar, Centring spigot, type RFE (INA)

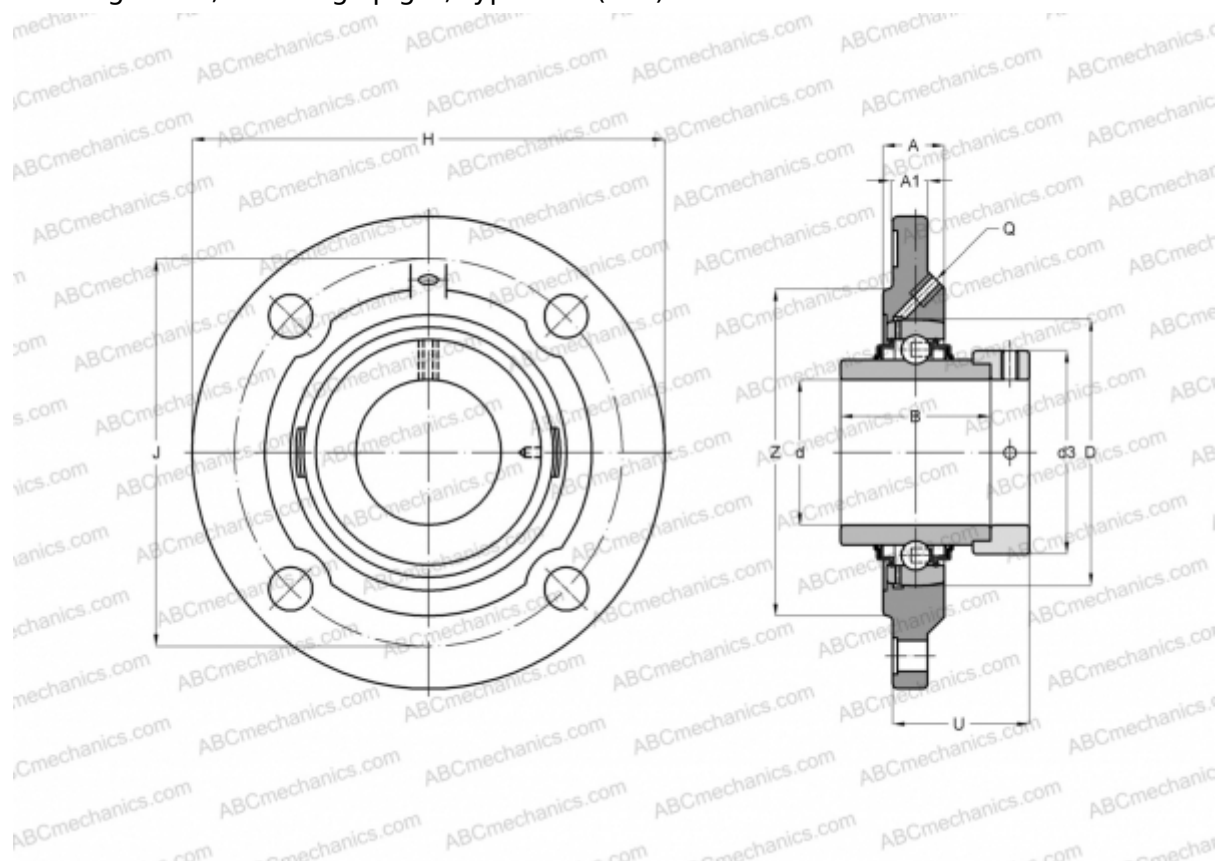

Technical specification

DIMENSIONS, MM

d	25,000
D	52,000
B	44,500
H	115,000
A	22,000
J	92,000
A1	9,000
N	9,000
d3	37,500
U	36,400
Z	75,000
Q	Rp1/8

WEIGHT, KG 0,800

Bearing	GE25-KRR-B
Housing	GG.FE05

MANUFACTURER

[INA](#)

CALCULATION DATA

Basic dynamic load rating, C	14,000 kN
Basic static load rating, Co	7,800 kN