

RFE60 INA

Ball bearing units

TYPE: Housing units, Four-bolt flanged housing units, Cast iron housing, Radial insert ball bearing with eccentric locking collar, Centring spigot, type RFE (INA)

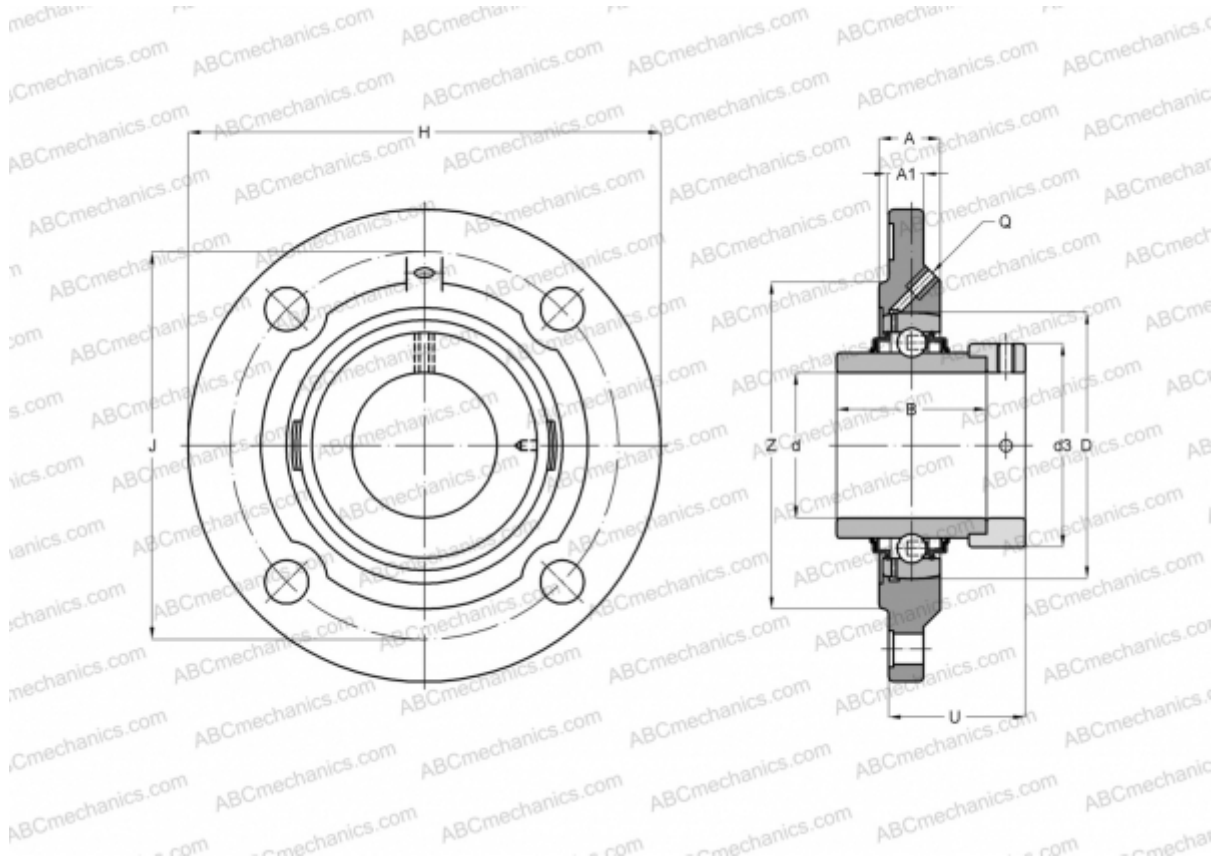

Technical specification

DIMENSIONS, MM

d	60,000
D	110,000
B	77,900
H	195,000
A	33,000
J	165,000
A1	16,000
N	14,000
d3	84,000
U	63,800
Z	140,000
Q	Rp1/8

WEIGHT, KG 3,990

Bearing	GE60-KRR-B
Housing	GG.FE12

MANUFACTURER

[INA](#)

CALCULATION DATA

Basic dynamic load rating, C	52,000 kN
Basic static load rating, Co	36,000 kN