

TFE35 INA

Ball bearing units

TYPE: Housing units, Four-bolt flanged housing units, Cast iron housing, Radial insert ball bearing with eccentric locking collar, Centring spigot, type TFE (INA)

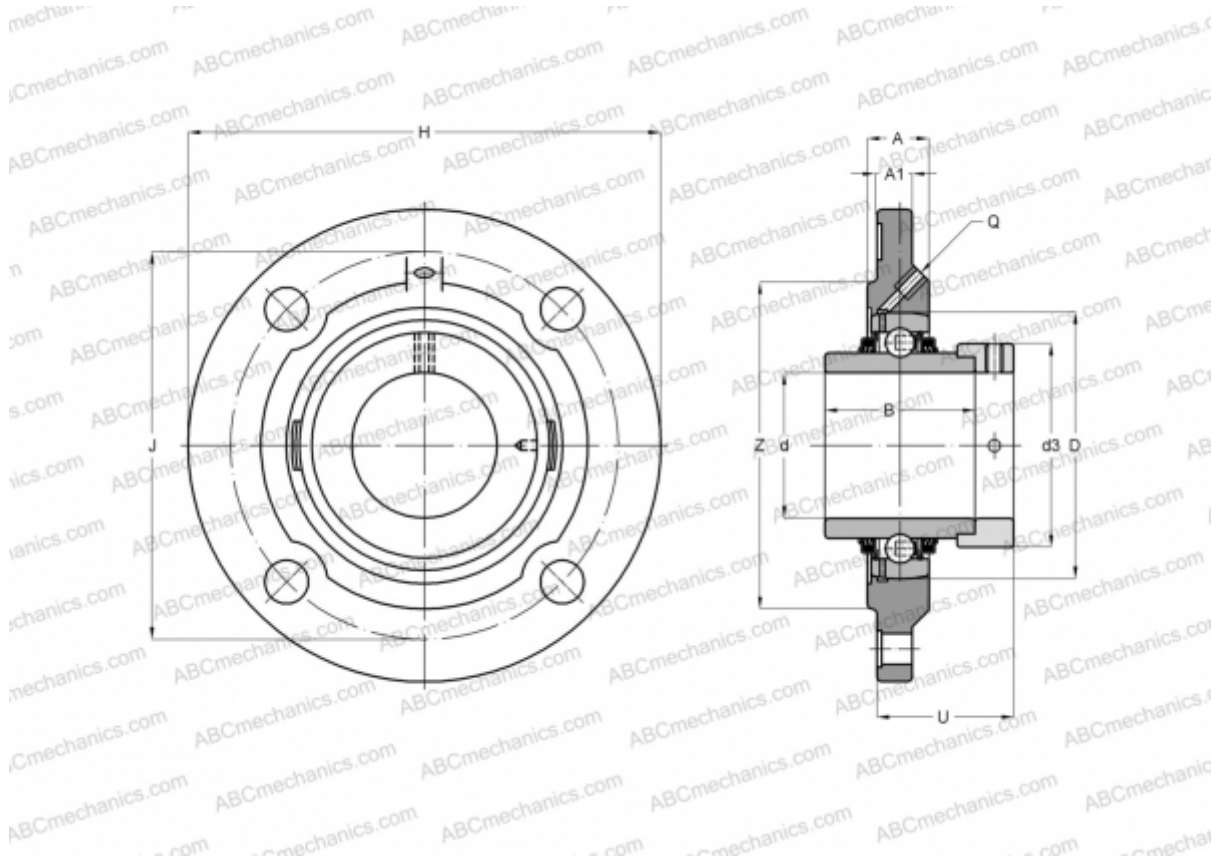

Technical specification

DIMENSIONS, MM

d	35,000
D	72,000
B	51,300
H	135,000
A	22,500
J	110,000
A1	10,000
N	11,500
d3	51,000
U	41,300
Z	90,000
Q	Rp1/8

WEIGHT, KG 1,300

Bearing	GE35-KTT-B
Housing	GG.FE07

MANUFACTURER

[INA](#)

CALCULATION DATA

Basic dynamic load rating, C	25,500 kN
Basic static load rating, Co	15,300 kN