

PCJY20-N INA

Ball bearing units

TYPE: Housing units, Four-bolt flanged housing units, Cast iron housing, Radial insert ball bearing with grub screws in inner ring, Type PCJY (INA)

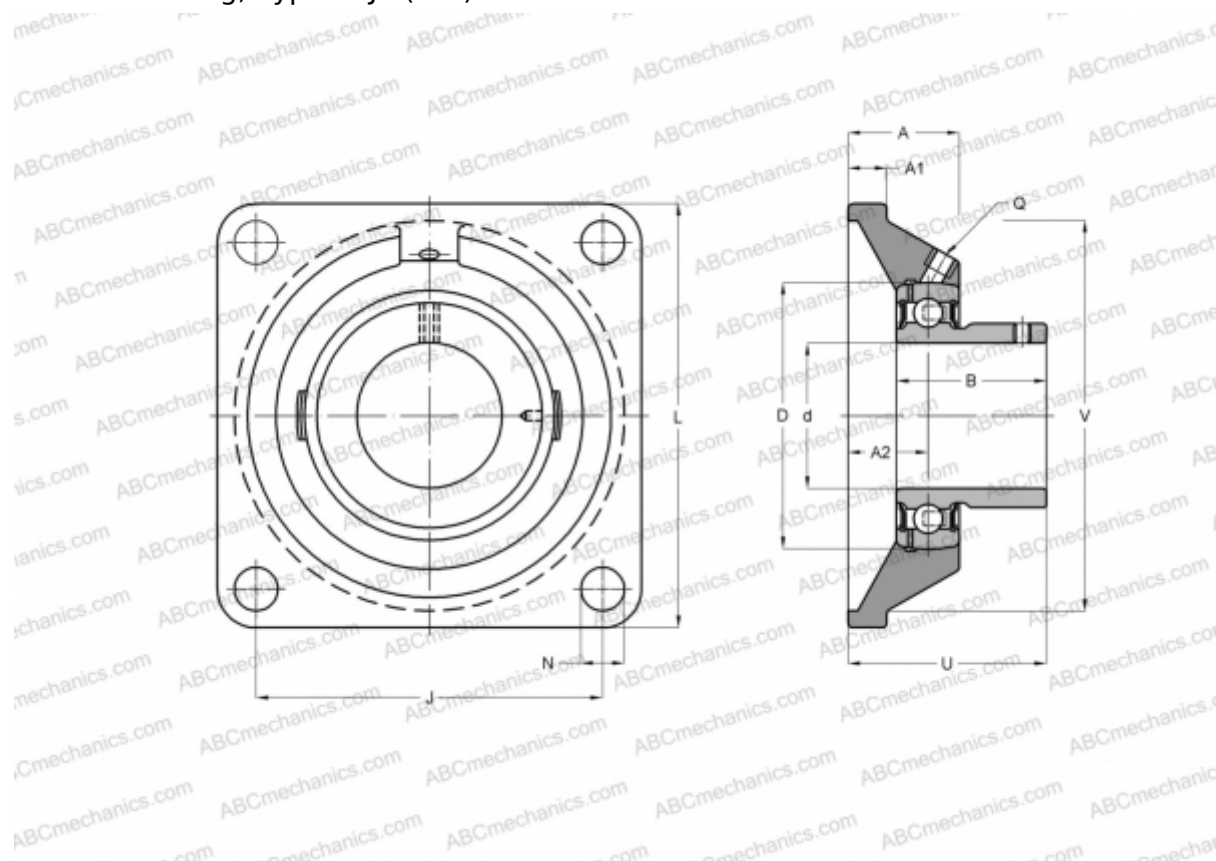

Technical specification

DIMENSIONS, MM

d	20,000
D	47,000
B	25,000
L	86,000
A	29,000
J	63,500
A1	10,000
A2	19,000
N	11,500
U	37,000
V	68,000
Q	Rp1/8

WEIGHT, KG 0,560

Bearing	GAY20-NPP-B
Housing	GG.CJ04-N

MANUFACTURER

[INA](#)

CALCULATION DATA

Basic dynamic load rating, C	12,800 kN
Basic static load rating, Co	6,600 kN