

PCJY30-N INA

Ball bearing units

TYPE: Housing units, Four-bolt flanged housing units, Cast iron housing, Radial insert ball bearing with grub screws in inner ring, Type PCJY (INA)

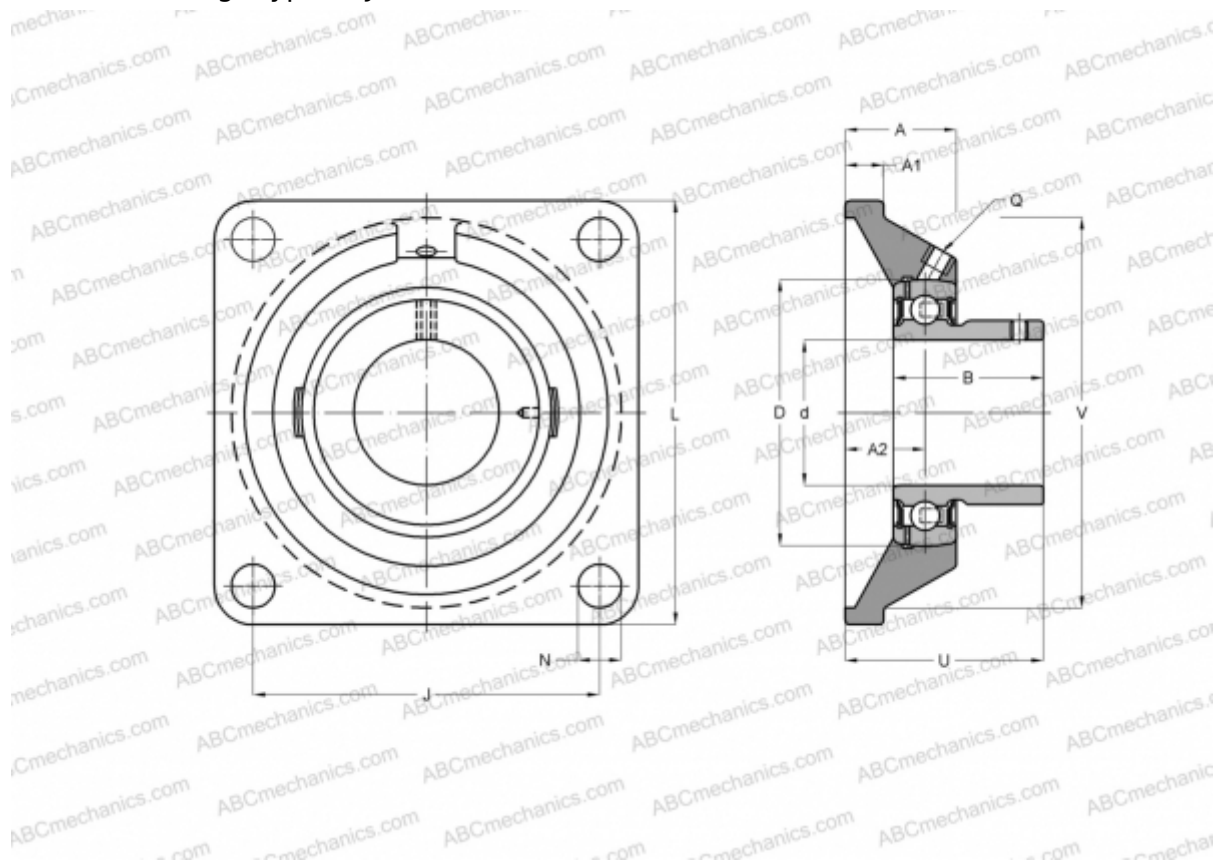

Technical specification

DIMENSIONS, MM

d	30,000
D	62,000
B	30,000
L	108,000
A	29,000
J	82,500
A1	12,000
A2	20,000
N	11,500
U	41,000
V	85,000
Q	Rp1/8

WEIGHT, KG 1,030

Bearing	GAY30-NPP-B
Housing	GG.CJ06-N

MANUFACTURER

[INA](#)

CALCULATION DATA

Basic dynamic load rating, C	19,500 kN
Basic static load rating, Co	11,300 kN