

RCJY15 INA

Ball bearing units

TYPE: Housing units, Four-bolt flanged housing units, Cast iron housing, Radial insert ball bearing with grub screws in inner ring, Type RCJY (INA)

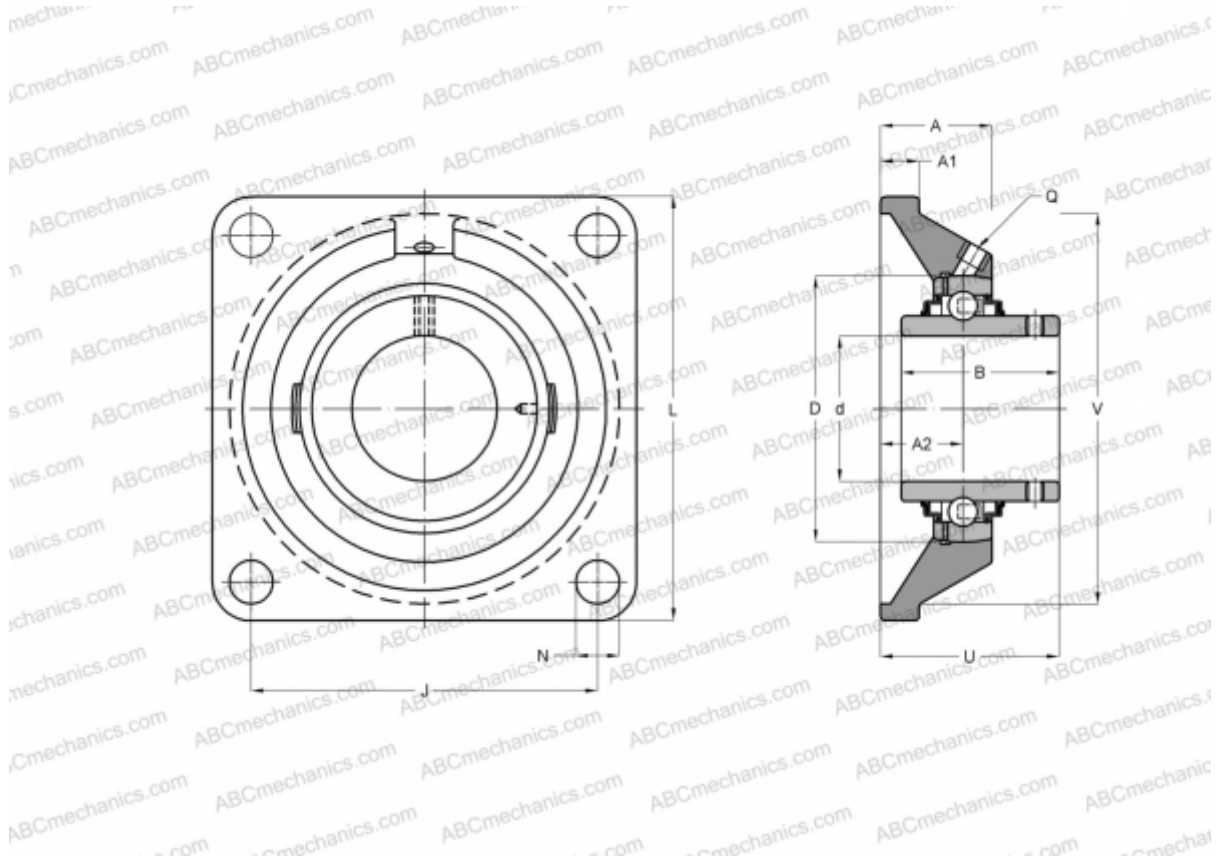

Technical specification

DIMENSIONS, MM

d	15,000
D	40,000
B	27,400
L	76,000
A	27,000
J	54,000
A1	9,500
A2	17,000
N	11,500
U	32,900
V	58,000
Q	M6

WEIGHT, KG 0,510

Bearing	GYE15-KRR-B
Housing	GG.CJ03

MANUFACTURER

[INA](#)

CALCULATION DATA

Basic dynamic load rating, C	9,800 kN
Basic static load rating, Co	4,750 kN