

## RCJY20-N INA

Ball bearing units

TYPE: Housing units, Four-bolt flanged housing units, Cast iron housing, Radial insert ball bearing with grub screws in inner ring, Type RCJY (INA)

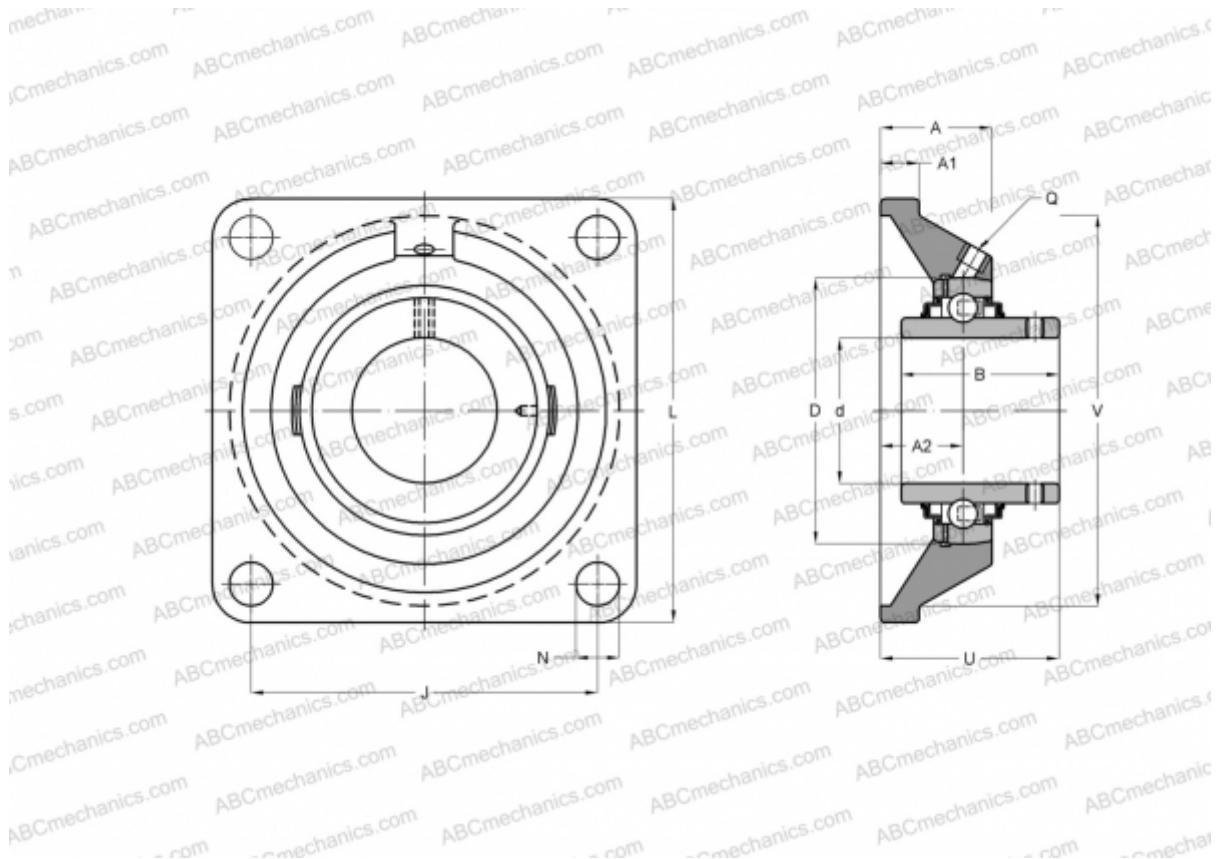

### Technical specification

#### DIMENSIONS, MM

d	20,000
D	47,000
B	31,000
L	86,000
A	29,000
J	63,500
A1	10,000
A2	19,000
N	11,500
U	37,300
V	68,000
Q	Rp1/8

#### WEIGHT, KG

0,620

Bearing

GYE20-KRR-B

Housing

GG.CJ04-N

#### MANUFACTURER

[INA](#)

#### CALCULATION DATA

Basic dynamic load rating, C	12,800 kN
Basic static load rating, Co	6,600 kN