

RCJY55 INA

Ball bearing units

TYPE: Housing units, Four-bolt flanged housing units, Cast iron housing, Radial insert ball bearing with grub screws in inner ring, Type RCJY (INA)

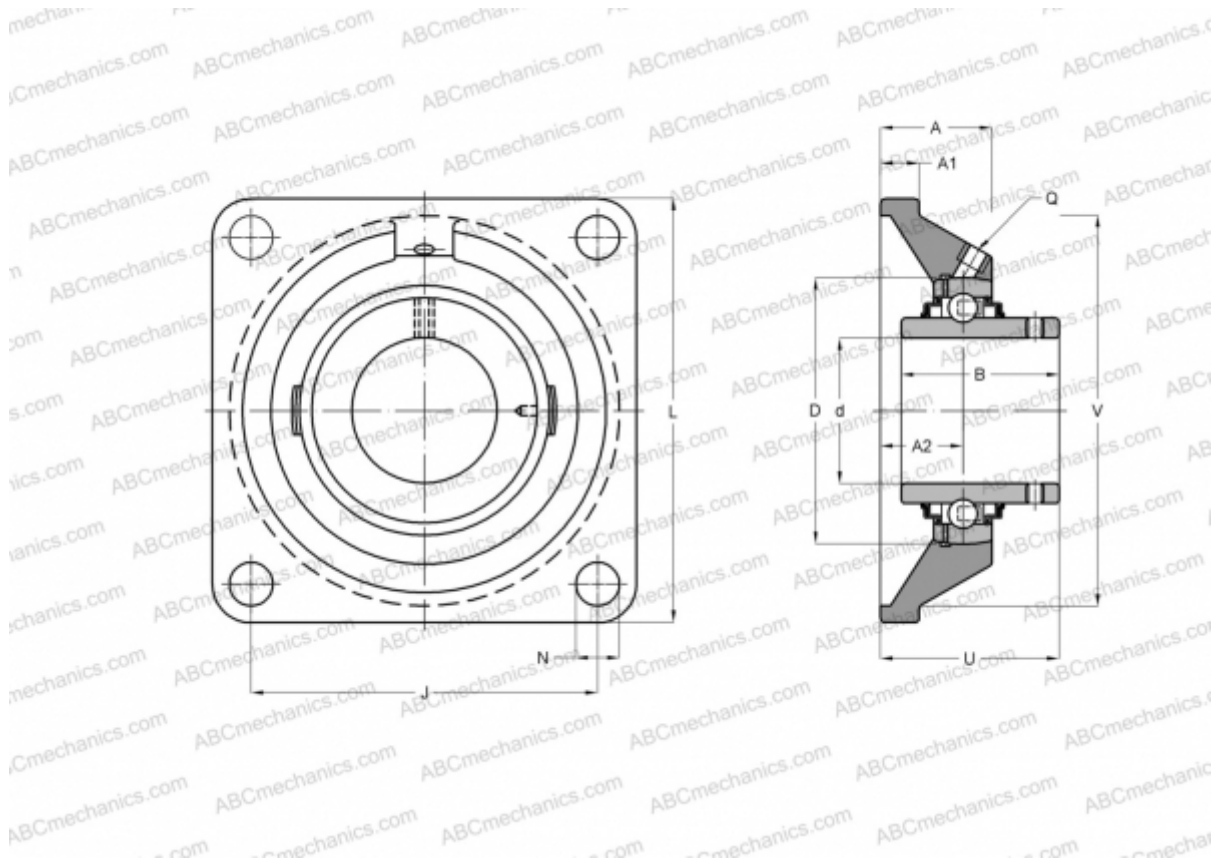

Technical specification

DIMENSIONS, MM

d	55,000
D	100,000
B	55,600
L	162,000
A	43,500
J	130,000
A1	15,000
A2	31,000
N	18,000
U	64,400
V	140,000
Q	Rp1/8

WEIGHT, KG 3,410

Bearing	GYE55-KRR-B
Housing	GG.CJ11

MANUFACTURER

[INA](#)

CALCULATION DATA

Basic dynamic load rating, C	43,500 kN
Basic static load rating, Co	29,000 kN