

RCJY70 INA

Ball bearing units

TYPE: Housing units, Four-bolt flanged housing units, Cast iron housing, Radial insert ball bearing with grub screws in inner ring, Type RCJY (INA)

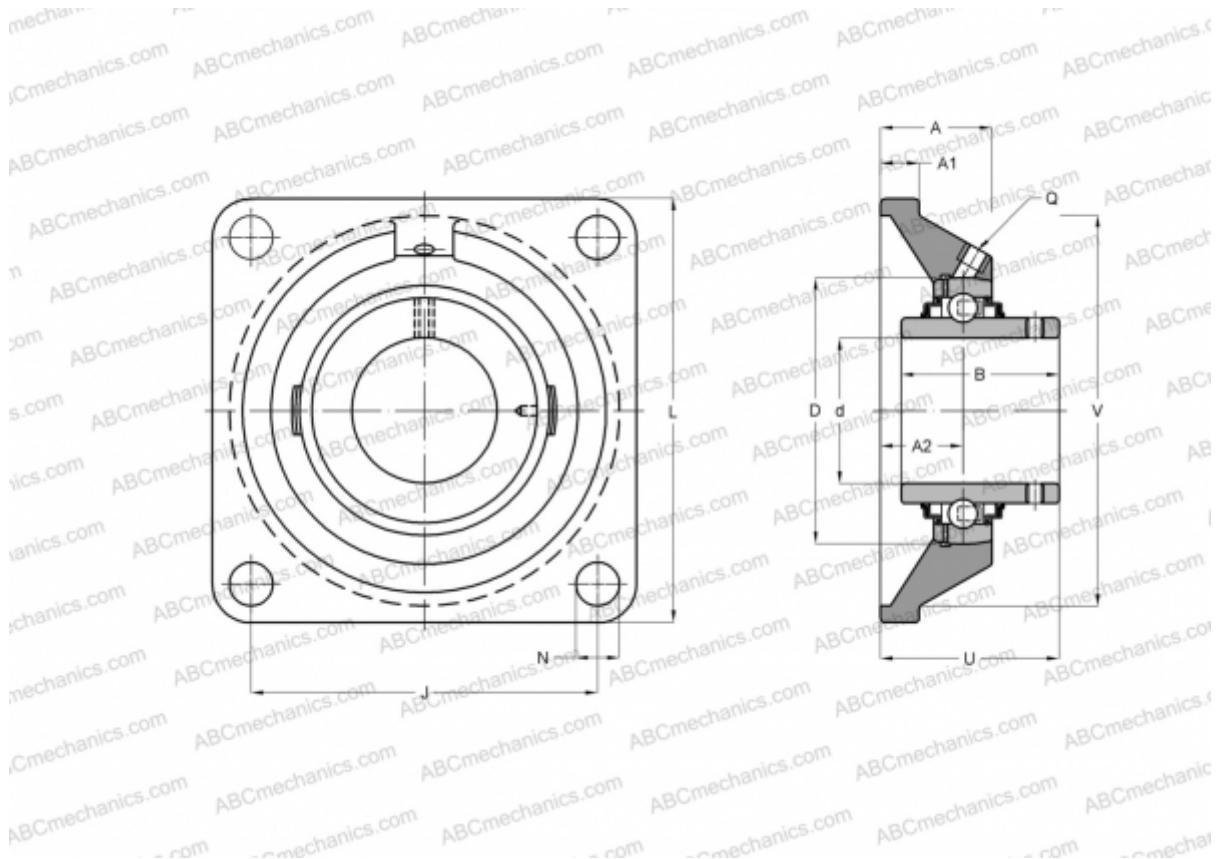

Technical specification

DIMENSIONS, MM

d	70,000
D	125,000
B	74,600
L	188,000
A	52,000
J	150,000
A1	18,000
A2	38,000
N	18,000
U	82,400
V	165,000
Q	Rp1/8

WEIGHT, KG 5,350

Bearing	GYE70-KRR-B
Housing	GG.CJ14

MANUFACTURER

[INA](#)

CALCULATION DATA

Basic dynamic load rating, C	62,000 kN
Basic static load rating, Co	44,000 kN