

RCJY90 INA

Ball bearing units

TYPE: Housing units, Four-bolt flanged housing units, Cast iron housing, Radial insert ball bearing with grub screws in inner ring, Type RCJY (INA)

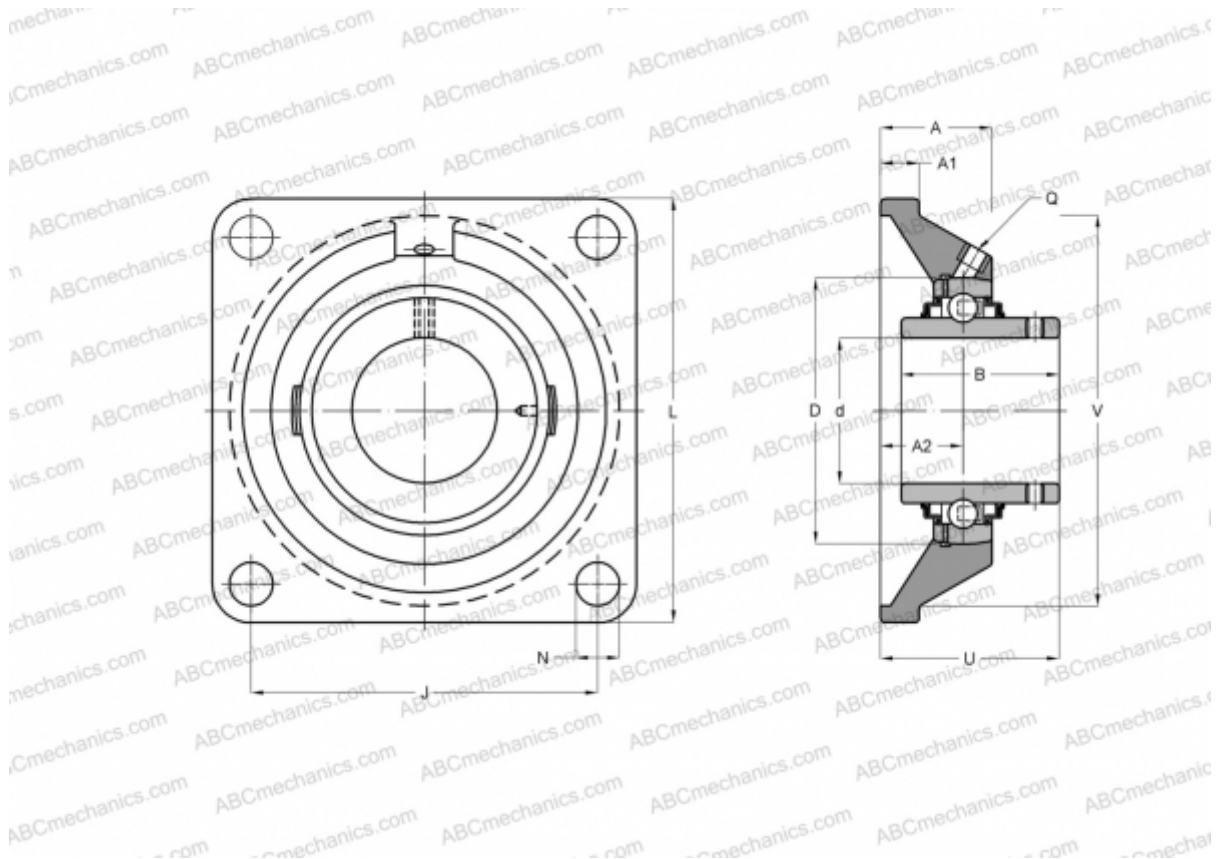

Technical specification

DIMENSIONS, MM

d	90,000
D	160,000
B	96,000
L	235,000
A	39,800
J	187,000
A1	22,000
A2	23,800
N	23,000
U	80,100
V	200,000
Q	Rp1/8

WEIGHT, KG 9,480

Bearing	GYE90-KRR-B
Housing	GG.CJ18

MANUFACTURER

[INA](#)

CALCULATION DATA

Basic dynamic load rating, C	96,000 kN
Basic static load rating, Co	72,000 kN