

RCJY20-JIS INA

Ball bearing units

TYPE: Housing units, Four-bolt flanged housing units, Cast iron housing, Radial insert ball bearing with grub screws in inner ring, Type RCJY...-JIS (INA)

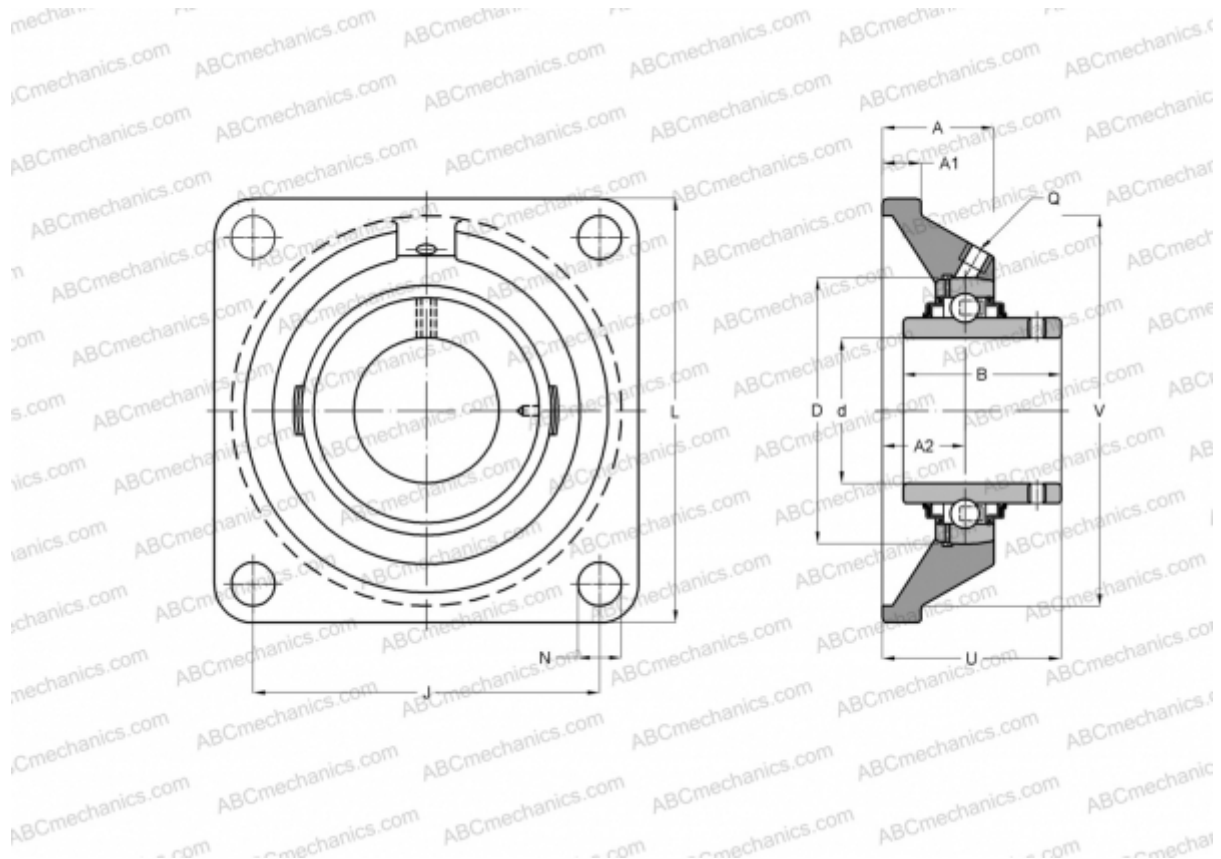

Technical specification

DIMENSIONS, MM

d	20,000
D	47,000
B	31,000
L	86,000
A	25,500
J	64,000
A1	12,000
A2	15,000
N	12,000
U	33,300
Q	M6

WEIGHT, KG 0,600

Bearing GYE20-KRR-B-FA107

Housing GG.F204

MANUFACTURER

[INA](#)

CALCULATION DATA

Basic dynamic load rating, C	12,800 kN
Basic static load rating, Co	6,600 kN