

RCJY40-JIS INA

Ball bearing units

TYPE: Housing units, Four-bolt flanged housing units, Cast iron housing, Radial insert ball bearing with grub screws in inner ring, Type RCJY...-JIS (INA)

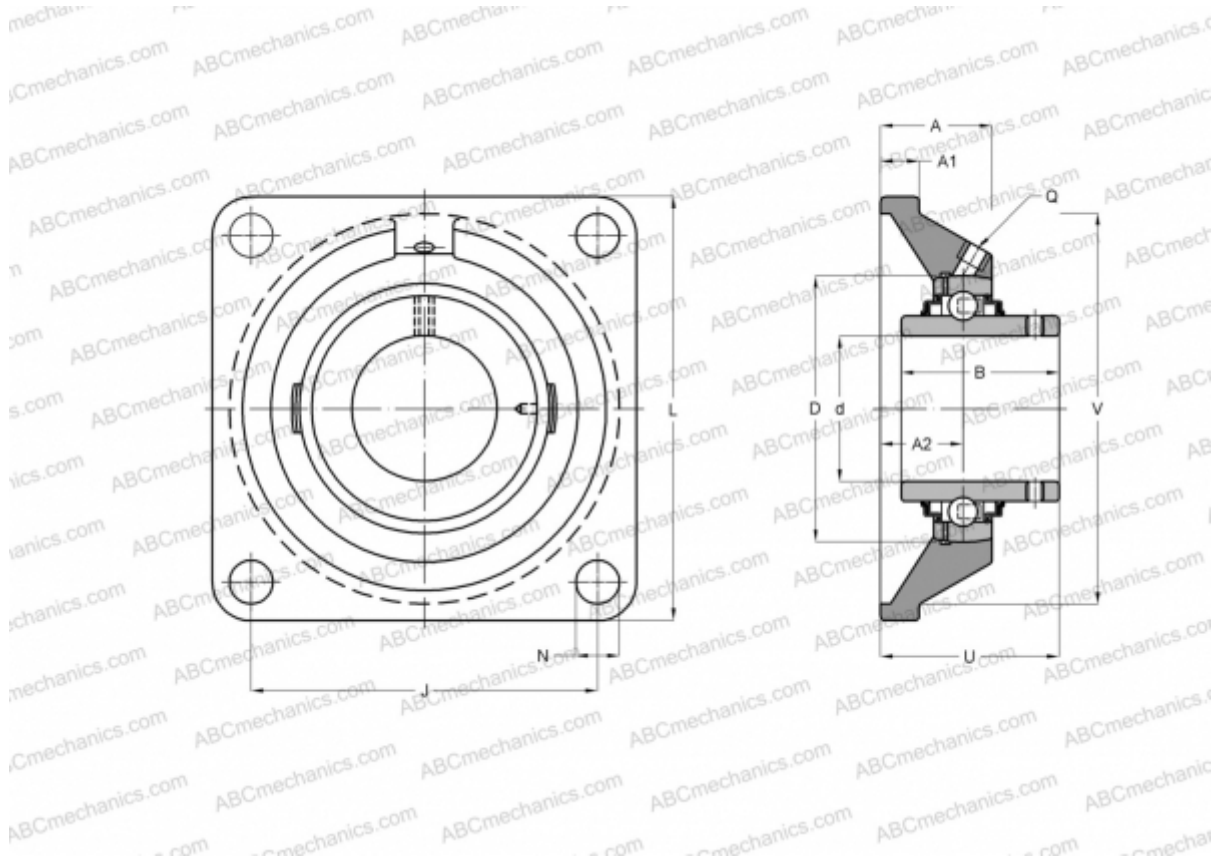

Technical specification

DIMENSIONS, MM

d	40,000
D	80,000
B	49,200
L	130,000
A	36,000
J	102,000
A1	16,000
A2	21,000
N	16,000
U	51,200
Q	M6

WEIGHT, KG 1,910

Bearing GYE40-KRR-B-FA107

Housing

GG.F208

MANUFACTURER

[INA](#)

CALCULATION DATA

Basic dynamic load rating, C	32,500 kN
Basic static load rating, Co	19,800 kN