

RCJY50-JIS INA

Ball bearing units

TYPE: Housing units, Four-bolt flanged housing units, Cast iron housing, Radial insert ball bearing with grub screws in inner ring, Type RCJY...-JIS (INA)

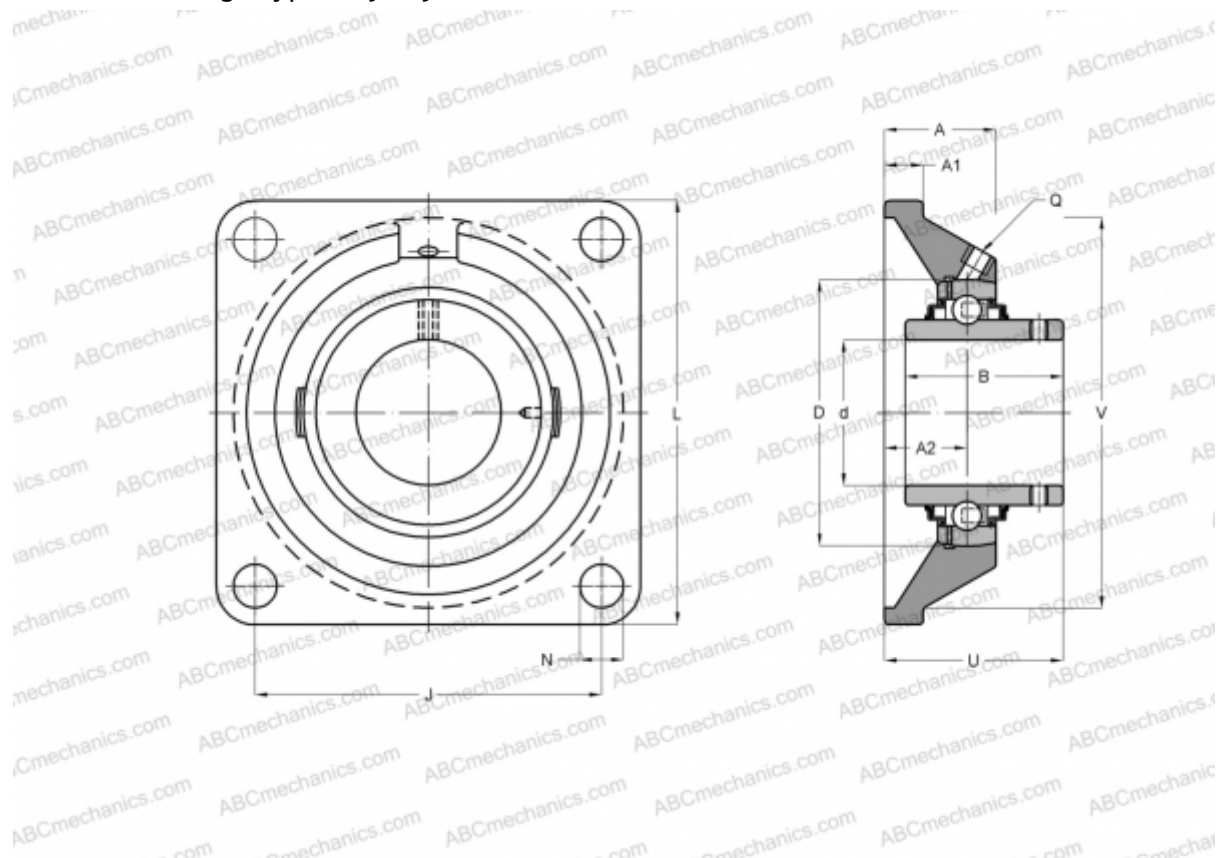

Technical specification

DIMENSIONS, MM

d	50,000
D	90,000
B	51,600
L	143,000
A	40,000
J	111,000
A1	18,000
A2	22,000
N	16,000
U	54,600
Q	M6

WEIGHT, KG 2,540

Bearing GYE50-KRR-B-FA107

Housing GG.F210

MANUFACTURER

[INA](#)

CALCULATION DATA

Basic dynamic load rating, C	35,000 kN
Basic static load rating, Co	23,200 kN