

PMEY30-N INA

Ball bearing units

TYPE: Housing units, Four-bolt flanged housing units, Cast iron housing, Radial insert ball bearing with grub screws in inner ring, Centring spigot, type PMEY (INA)

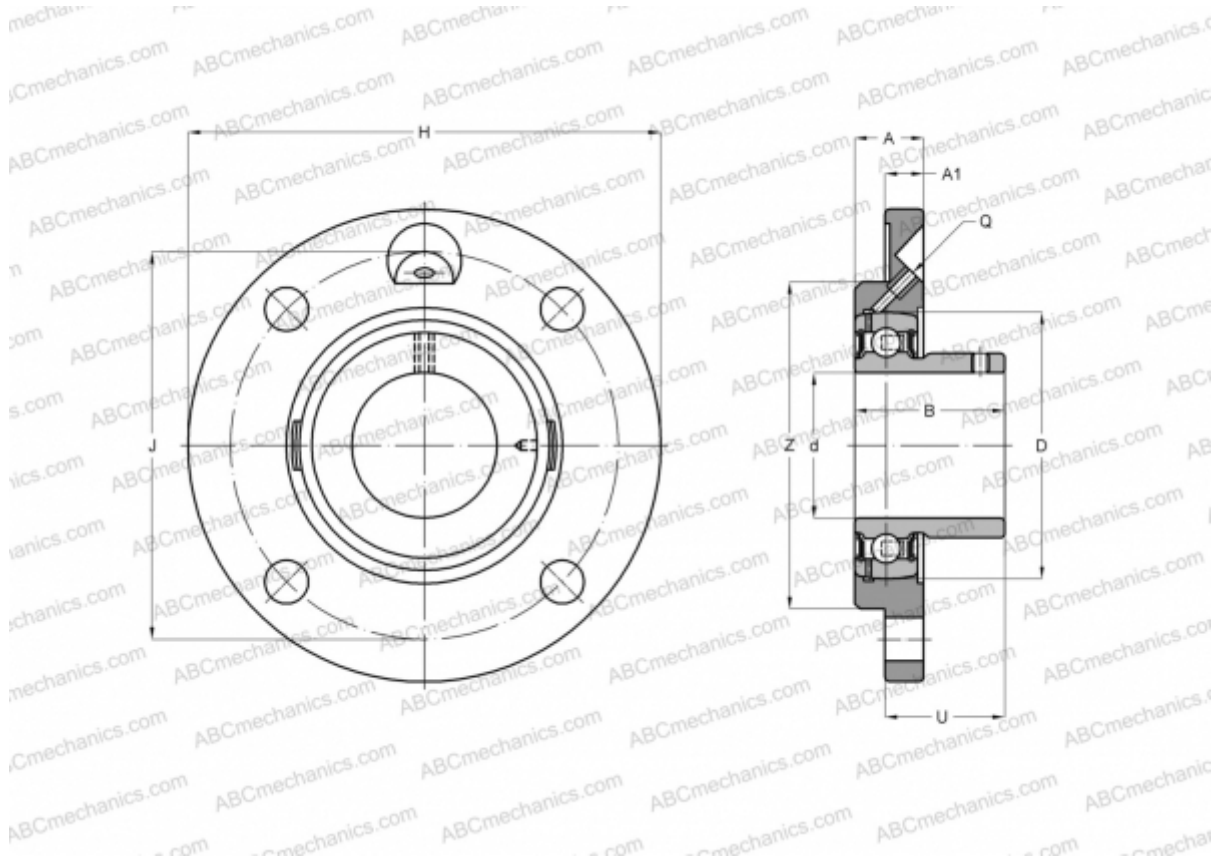

Technical specification

DIMENSIONS, MM

d	30,000
D	62,000
B	30,000
H	125,000
A	20,500
J	100,000
A1	9,500
N	11,500
U	19,000
Z	80,000
Q	M6

WEIGHT, KG 0,900

Bearing GAY30-NPP-B

Housing	GG.ME06-N
Protective cover	KASK06

MANUFACTURER

[INA](#)

CALCULATION DATA

Basic dynamic load rating, C	19,500 kN
Basic static load rating, Co	11,300 kN