

PMEY35-N INA

Ball bearing units

TYPE: Housing units, Four-bolt flanged housing units, Cast iron housing, Radial insert ball bearing with grub screws in inner ring, Centring spigot, type PMEY (INA)

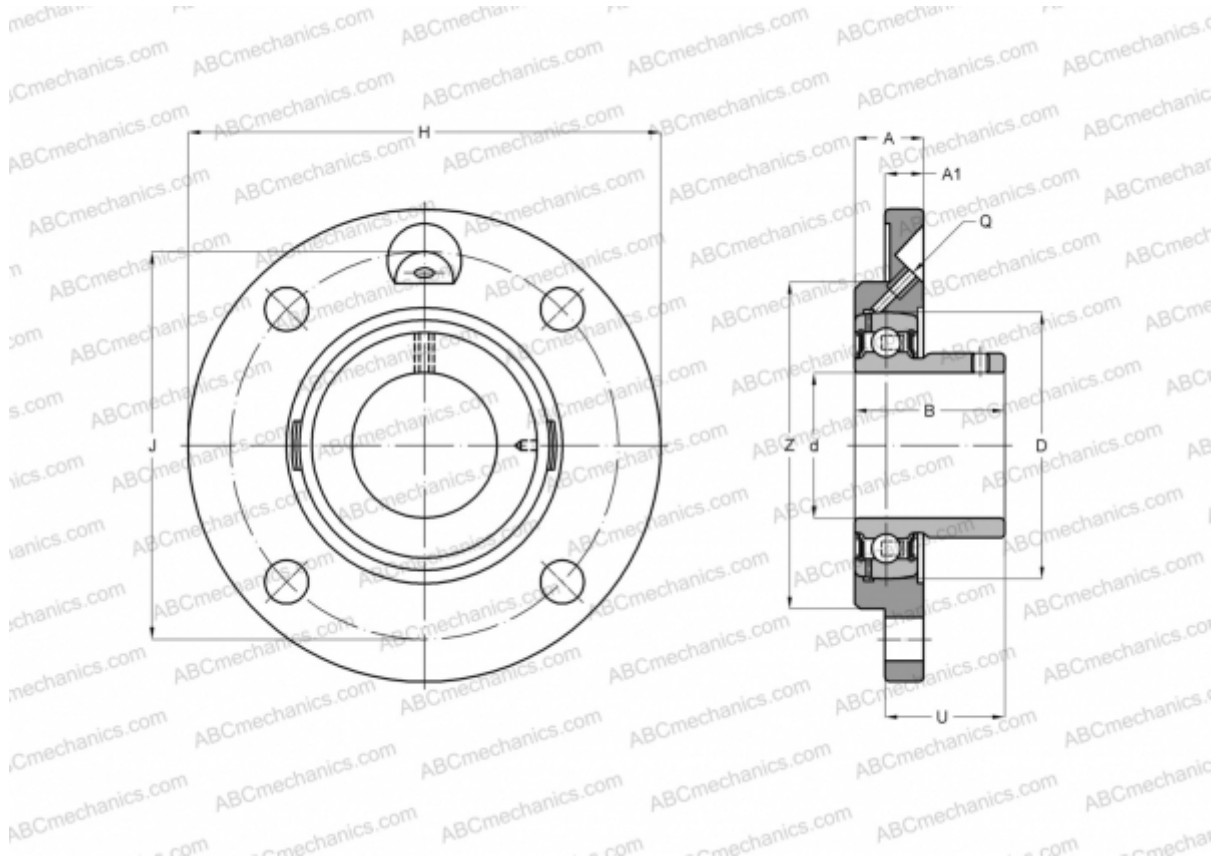

Technical specification

DIMENSIONS, MM

d	35,000
D	72,000
B	34,950
H	135,000
A	20,500
J	110,000
A1	10,000
N	11,500
U	24,450
Z	90,000
Q	M6

WEIGHT, KG 1,150

Bearing GAY35-NPP-B

Housing	GG.ME07-N
Protective cover	KASK07

MANUFACTURER

[INA](#)

CALCULATION DATA

Basic dynamic load rating, C	25,500 kN
Basic static load rating, Co	15,300 kN