

RMEY75 INA

Ball bearing units

TYPE: Housing units, Four-bolt flanged housing units, Cast iron housing, Radial insert ball bearing with grub screws in inner ring, Centring spigot, type RMEY (INA)

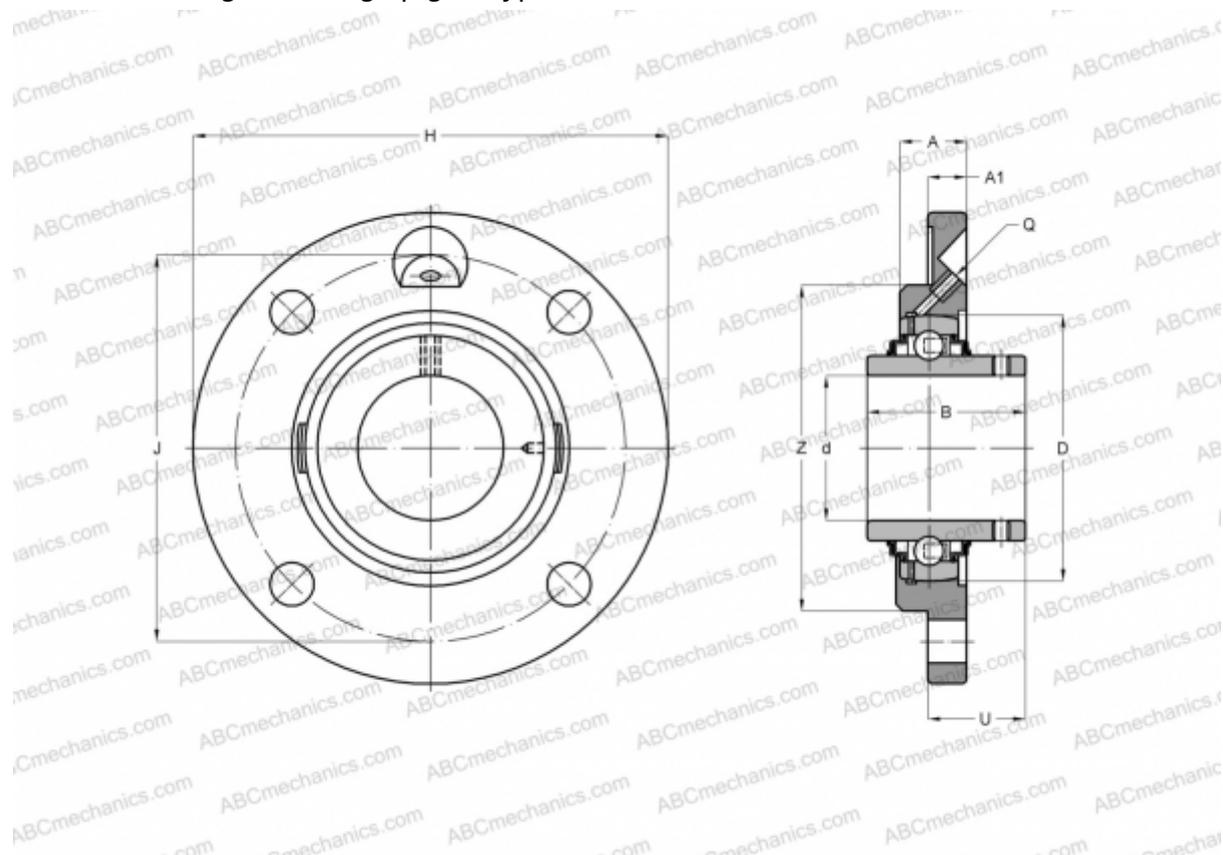

Technical specification

DIMENSIONS, MM

d	75,000
D	130,000
B	77,800
H	220,000
A	32,000
J	184,000
A1	18,000
N	18,000
U	44,500
Z	160,000
Q	Rp1/8

WEIGHT, KG 5,190

Bearing GYE75-KRR-B

Housing GG.ME15

MANUFACTURER [INA](#)

CALCULATION DATA

Basic dynamic load rating, C	62,000 kN
Basic static load rating, Co	44,500 kN