

RCJL35-N INA

Ball bearing units

TYPE: Housing units, Four-bolt flanged housing units, Cast iron housing, Non-locating bearing, drive slot on inner ring, Type RCJL (INA), for temperatures from -40°/+180°C

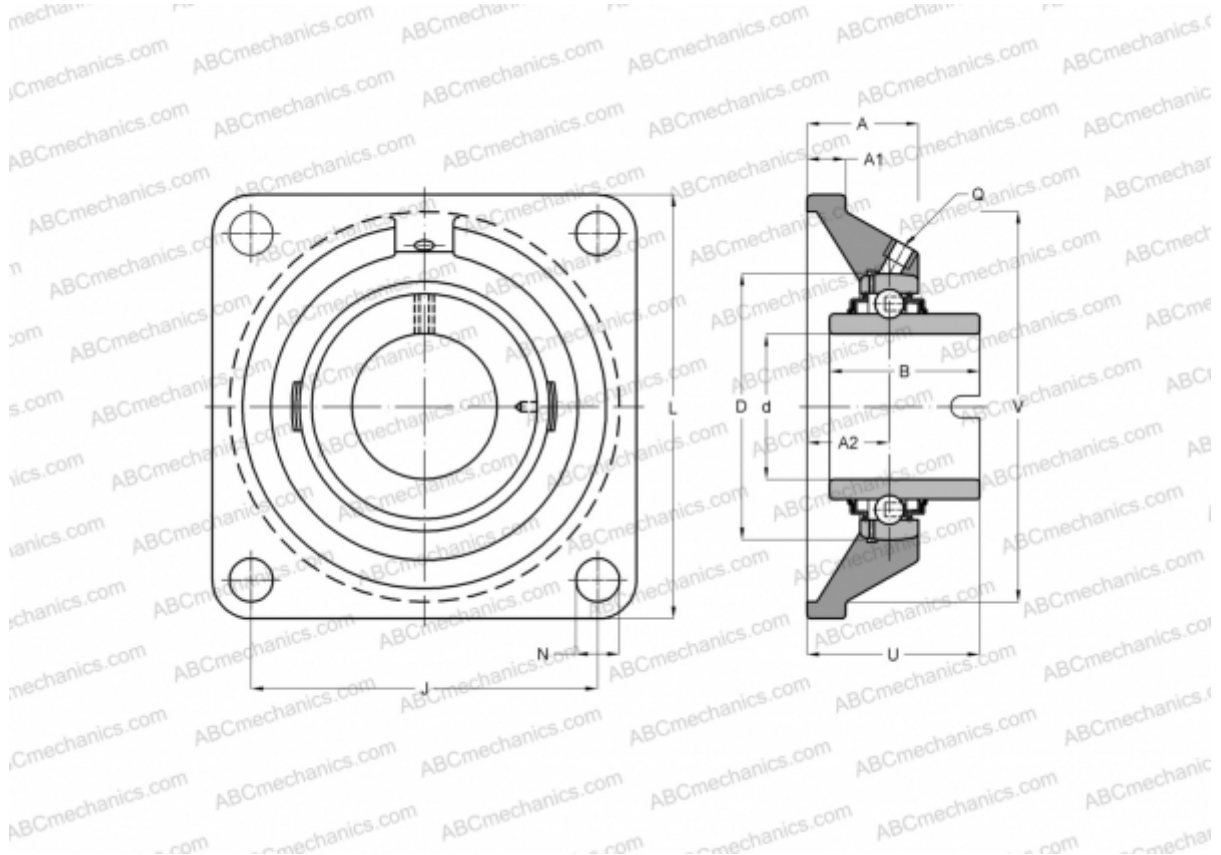

Technical specification

DIMENSIONS, MM

d	35,000
D	72,000
B	37,700
L	118,000
A	30,500
J	92,000
A1	12,500
A2	21,000
N	14,000
U	43,000
V	100,000
Q	Rp1/8

WEIGHT, KG

1,410

Bearing	GLE35-KRR-B
Housing	GG.CJ07-N

MANUFACTURER

[INA](#)

CALCULATION DATA

Basic dynamic load rating, C	25,500 kN
Basic static load rating, Co	15,300 kN
Operating temperature min	-40 °C
Operating temperature max	180 °C