

RCJL60-N INA

Ball bearing units

TYPE: Housing units, Four-bolt flanged housing units, Cast iron housing, Non-locating bearing, drive slot on inner ring, Type RCJL (INA), for temperatures from -40°/+180°C

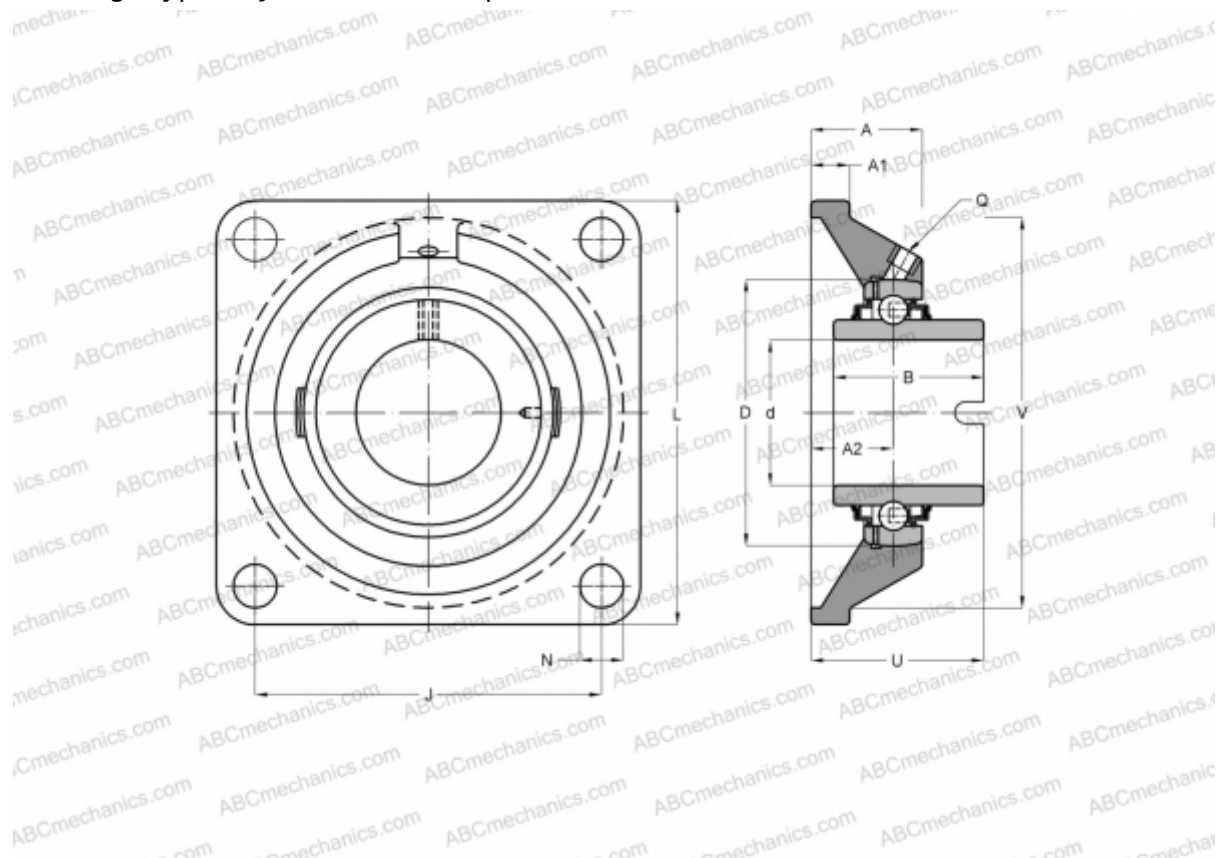

Technical specification

DIMENSIONS, MM

d	60,000
D	110,000
B	61,900
L	175,000
A	46,000
J	143,000
A1	16,000
A2	34,000
N	18,000
U	71,300
V	150,000
Q	Rp1/8

WEIGHT, KG

4,220

Bearing	GLE60-KRR-B
Housing	GG.CJ12-N

MANUFACTURER

[INA](#)

CALCULATION DATA

Basic dynamic load rating, C	52,000 kN
Basic static load rating, Co	36,000 kN
Operating temperature min	-40 °C
Operating temperature max	180 °C