

PTUE35 INA

Ball bearing units

TYPE: Housing units, Take-up housing units, Cast iron housing, Radial insert ball bearing with eccentric locking collar, Type PTUE (INA)

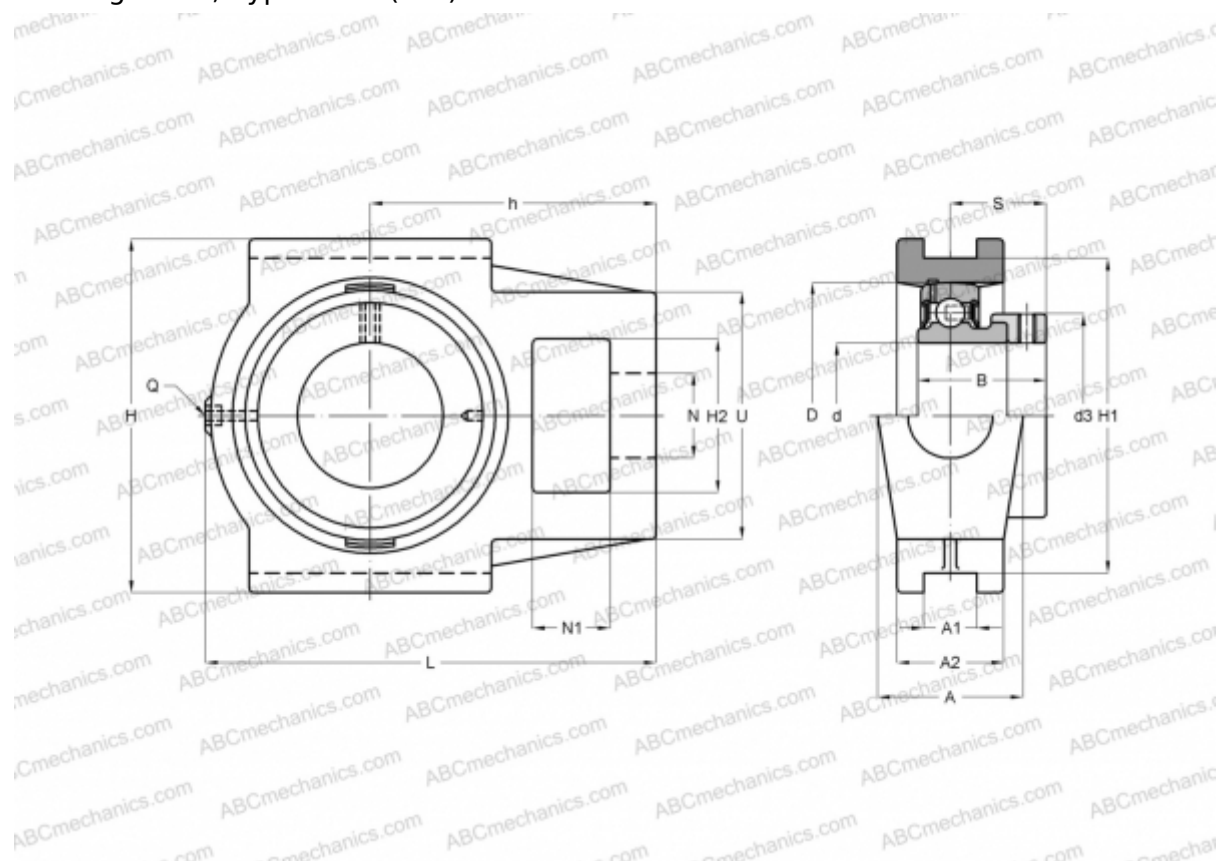

Technical specification

DIMENSIONS, MM

d	35,000
D	72,000
B	39,000
L	131,500
H	102,000
A	40,000
H2	36,500
A1	12,000
A2	30,000
H1	89,000
N	22,000
N1	18,000
S	29,400
d3	51,000
U	64,000

DIMENSIONS, MM

h	80,000
Q	Rp1/8

WEIGHT, KG

Bearing	GRAE35-NPP-B
Housing	GG.TUE07

MANUFACTURER

[INA](#)

CALCULATION DATA

Basic dynamic load rating, C	25,500 kN
Basic static load rating, Co	15,300 kN