

PTUE40 INA

Ball bearing units

TYPE: Housing units, Take-up housing units, Cast iron housing, Radial insert ball bearing with eccentric locking collar, Type PTUE (INA)

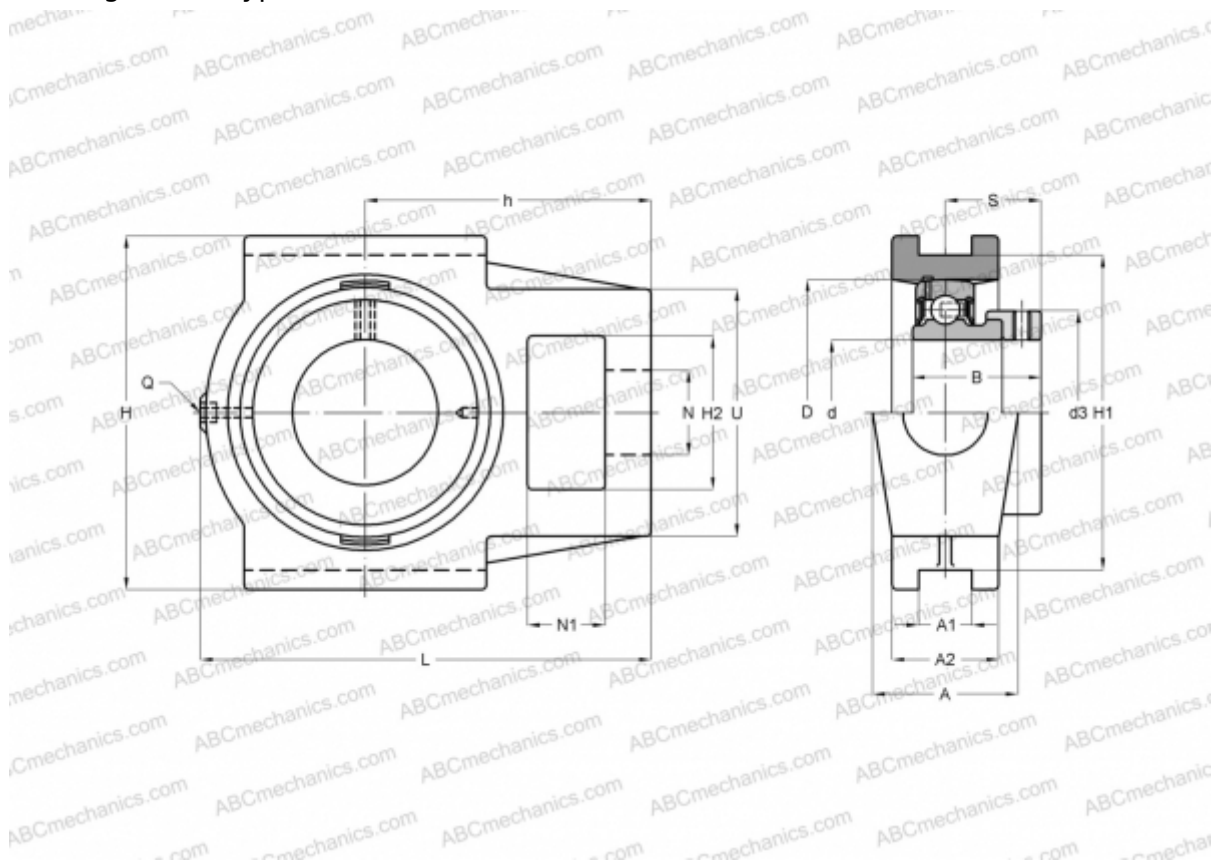

Technical specification

DIMENSIONS, MM

d	40,000
D	80,000
B	43,800
L	141,000
H	115,000
A	50,000
H2	49,000
A1	16,000
A2	35,000
H1	102,000
N	29,000
N1	20,000
S	32,800
d3	58,000
U	82,000

DIMENSIONS, MM

h	88,000
Q	Rp1/8

WEIGHT, KG

Bearing	GRAE40-NPP-B
Housing	GG.TUE08

MANUFACTURER

[INA](#)

CALCULATION DATA

Basic dynamic load rating, C	32,500 kN
Basic static load rating, Co	19,800 kN