

PTUE55 INA

Ball bearing units

TYPE: Housing units, Take-up housing units, Cast iron housing, Radial insert ball bearing with eccentric locking collar, Type PTUE (INA)

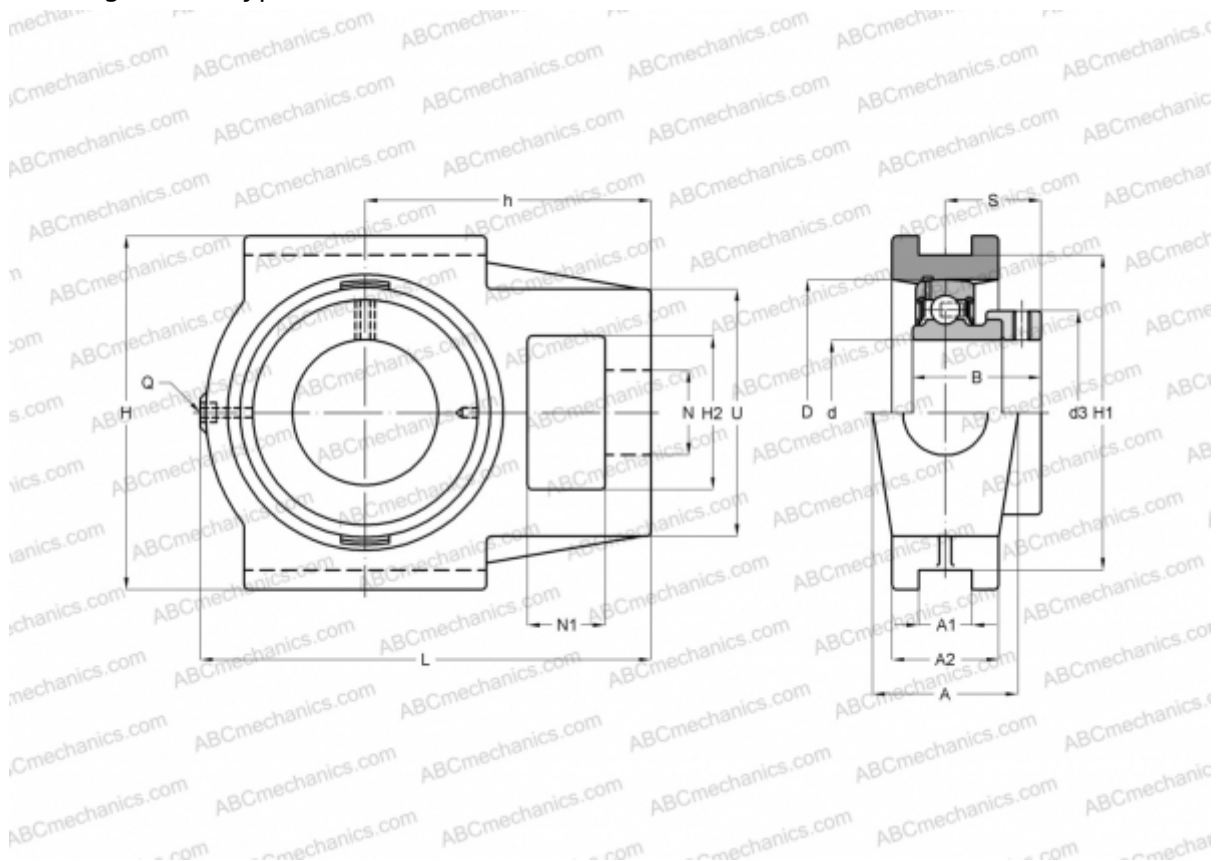

Technical specification

DIMENSIONS, MM

d	55,000
D	100,000
B	48,400
L	169,000
H	145,000
A	60,000
H2	63,500
A1	22,000
A2	42,000
H1	130,000
N	35,000
N1	26,000
S	36,400
d3	76,000
U	102,000

DIMENSIONS, MM

h	104,000
Q	Rp1/8

WEIGHT, KG

Bearing	GRAE55-NPP-B
Housing	GG.TUE11

MANUFACTURER

[INA](#)

CALCULATION DATA

Basic dynamic load rating, C	43,500 kN
Basic static load rating, Co	29,000 kN